

AMMP-5620

6 – 20 GHz High Gain Amplifier in SMT Package



Data Sheet

Description

The AMMP-5620 MMIC is a GaAs wide-band amplifier in a surface mount package designed for medium output power and high gain over the 6-20 GHz frequency range. The 3 cascaded stages provide high gain while the single bias supply offers ease of use. It is fabricated using a PHEMT integrated circuit process. The RF input and output ports have matching circuitry for use in 50-ohms environments. The MMIC is a cost effective alternative to hybrid (discrete FET) amplifiers that require complex tuning and assembly processes.

Package Diagram

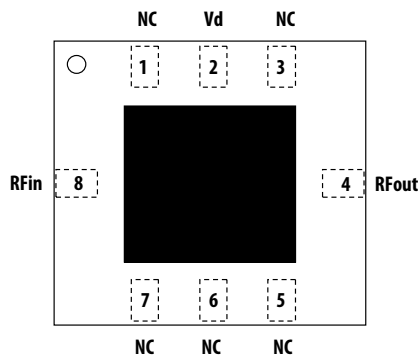

Pin	Function
1	NC
2	Vd
3	NC
4	RF_out
5	NC
6	NC
7	NC
8	RF_in

Features

- Surface Mount Package, 5.0 x 5.0 x 1.25 mm
- Wide Frequency Range 6-20 GHz
- High Gain: 17.5 dB Typical
- Medium Output P1dB: 14.8 dBm Typical
- Input and Output Return Loss: <-10 dB Typical
- 50 Ohm Input and Output Match
- Single Supply Bias: 5V @ 95 mA Typical

Applications

- General purpose, wideband amplifier in communication systems or microwave instrumentation
- High Gain Amplifier

Functional Block Diagram

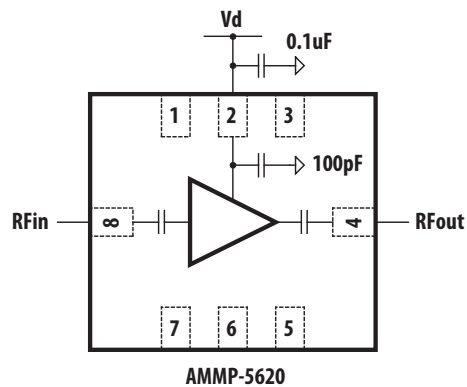

Note: Package base: GND



Attention: Observe precautions for handling electrostatic sensitive devices.
 ESD Machine Model (40V)
 ESD Human Body Model (150V)
 Refer to Avago Application Note A004R: Electrostatic Discharge, Damage and Control.

Note: MSL Rating = Level 2A

Electrical Specifications

1. Small/large signal data measured in a fully de-embedded test fixture at TA = 25 degree Celsius.
2. Specifications are derived from measurements in a 50 Ohm test environment. Aspects of the amplifier performance may be improved over a narrower bandwidth by application of additional conjugate, linearity, or low noise matching.
3. All tested parameters guaranteed with measurement accuracy ± 0.5 dB for NF and ± 1.0 dB for gain.

Table 1. RF Electrical Characteristics (TA=25°C, Freq=18GHz, Vd=5.0V, Idq=95mA)

Parameter	Min	Typ.	Max	Unit
Small-signal Gain, Gain	15.5	17.5	19.5	dB
Noise Figure, NF		5.1	7.0	dB
Output Power at 1dB Gain Compression, P1dB		14.8		dBm
Third Order Intercept Point, OIP3		22.5		dBm
Input Return Loss, RLin		11.5		dB
Output Return Loss, RLout		11.6		dB
Reverse Isolation, Isolation		-43.0		dB

Table 2. Recommended Operating Range

Description	Min.	Typical	Max.	Unit
Drain Supply Voltage, Vd		5		V
Drain Supply Current, Id	70	95	130	mA

Notes:

1. Ambient operation temperature TA = 25°C unless otherwise noted.
2. Channel-to-board Thermal Resistance is measured using Infrared Microscopy method.

Table 3. Thermal Properties

Parameter	Test Conditions	Value
Thermal Resistance, θ_{jc}		$\theta_{jc} = 28$ °C/W

Note: Channel-to-board Thermal Resistance is measured using Infrared Microscopy method.

Absolute Minimum and Maximum Ratings

Table 4. Minimum and Maximum Ratings

Description	Min.	Max.	Unit	Comments
Drain Supply Voltage, Vd		7.5	V	
Total Drain Current, Id		135	mA	
RF Input Power, Pin		20	dBm	CW
Power Dissipation, Pd		1.0	W	
Channel Temperature, Tch		+150	°C	
Storage Temperature, Tstg	-65	+150	°C	
Maximum Assembly Temperature, Tmax		+260	°C	

Notes:

1. Operation in excess of any one of these conditions may result in permanent damage to this device. The absolute maximum ratings for Vd, Id, Pd and Pin were determined at an ambient temperature of 25°C unless noted otherwise.

Selected performance plots

All data measured on at $V_d = 5V$, $I_d = 95mA$, $T_a = 25^\circ C$, and $50\ \Omega$ at all ports.

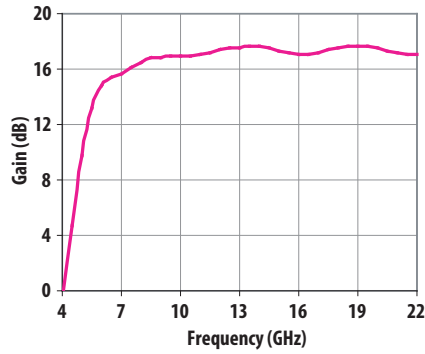

Figure 1. Gain

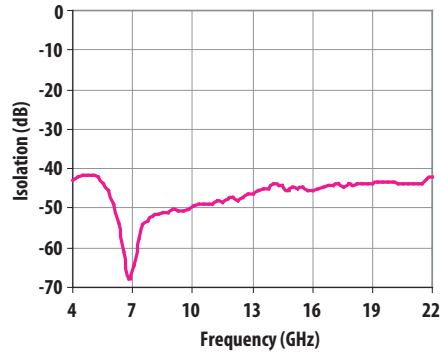

Figure 2. Isolation

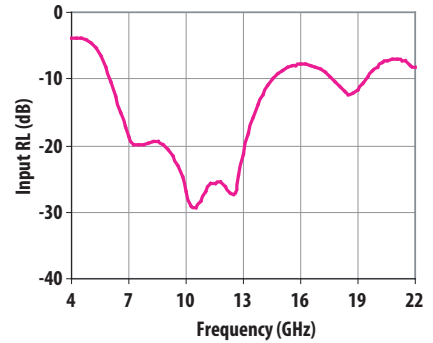

Figure 3. Input Return Loss

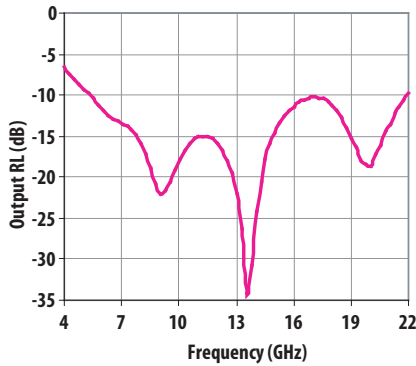

Figure 4. Output Return Loss

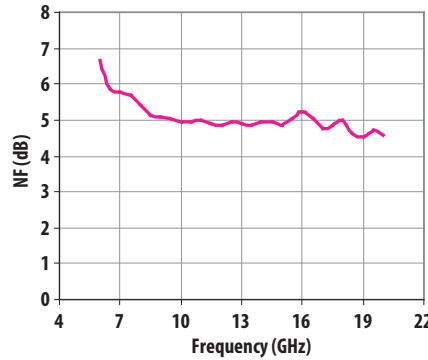

Figure 5. Noise Figure

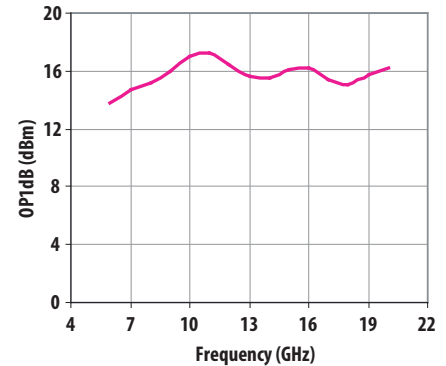

Figure 6. P1dB

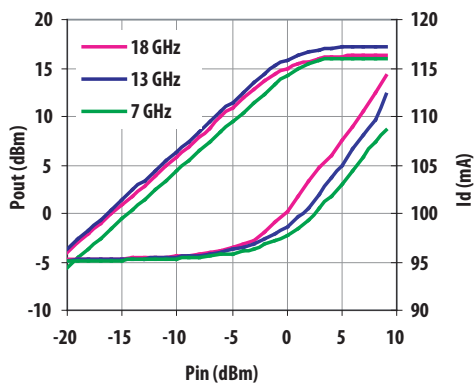

Figure 7. Pout and Id vs. Pin

Note: These measurements are obtained using demo board with 50 Ohm traces at input and output. Aspects of the amplifier performance may be improved over a narrower bandwidth by application of additional conjugate, linearity or low noise matching.

Over Voltage plots

All data measured on at $V_d = 5V$, $I_d = 95mA$, $T_a = 25^\circ C$, and $50\ \Omega$ at all ports.

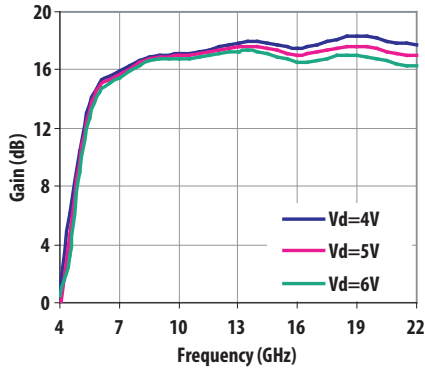

Figure 8. Gain and Voltage

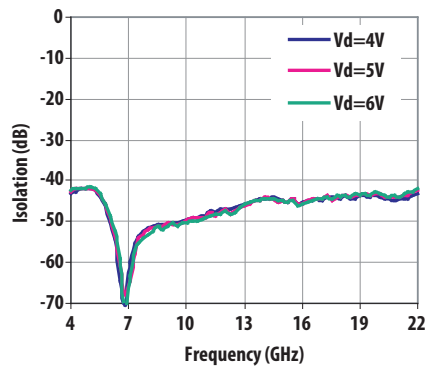

Figure 9. Isolation and Voltage

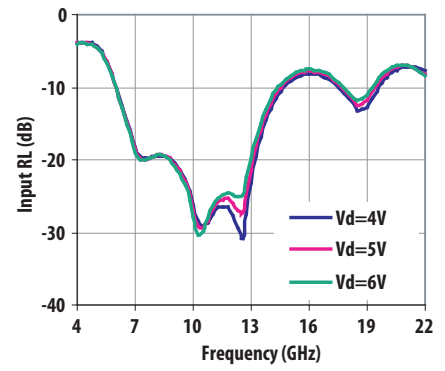

Figure 10. Input Return Loss and Voltage

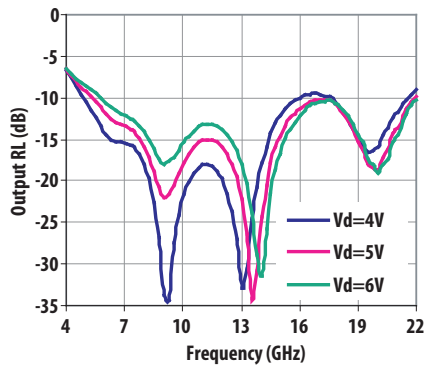

Figure 11. Output Return Loss and Voltage

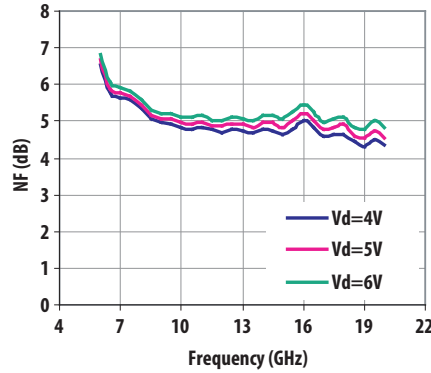

Figure 12. Noise Figure and Voltage

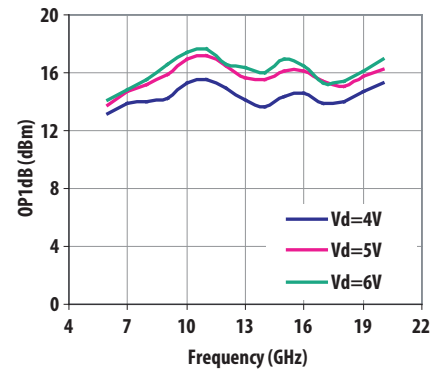

Figure 13. P1dB and Voltage

Note: These measurements are obtained using demo board with 50 Ohm traces at input and output. Aspects of the amplifier performance may be improved over a narrower bandwidth by application of additional conjugate, linearity or low noise matching.

Over Temperature Performance Plots

All data measured on at $V_d = 5V$, $I_d = 95mA$, $T_a = 25^\circ C$, and $50\ \Omega$ at all ports

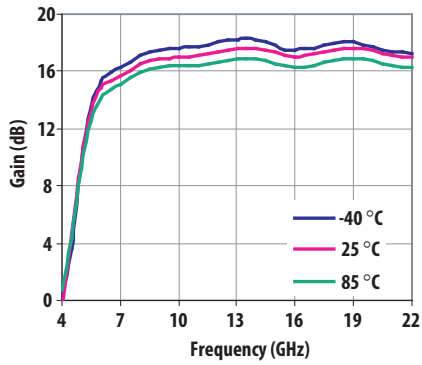

Figure 14. Gain and Temperature

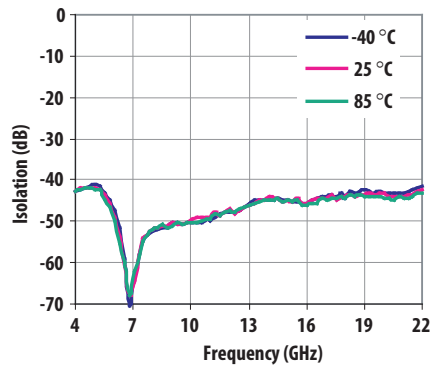

Figure 15. Isolation and Temperature

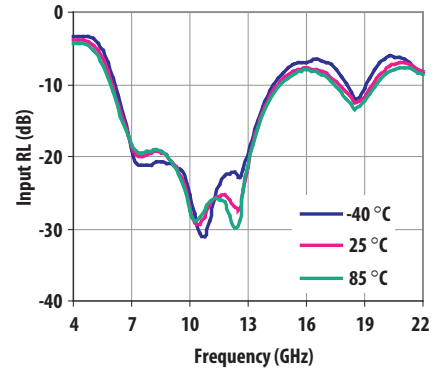

Figure 16. Input Return Loss and Temperature

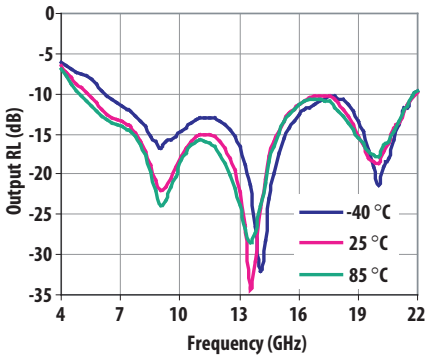

Figure 17. Output Return Loss and Temperature

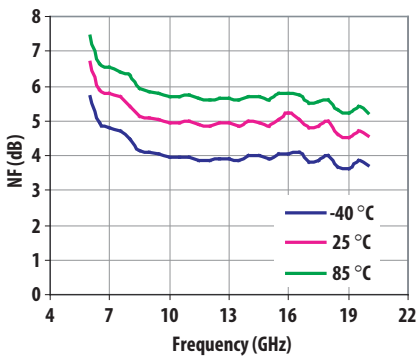

Figure 18. Noise Figure and Temperature

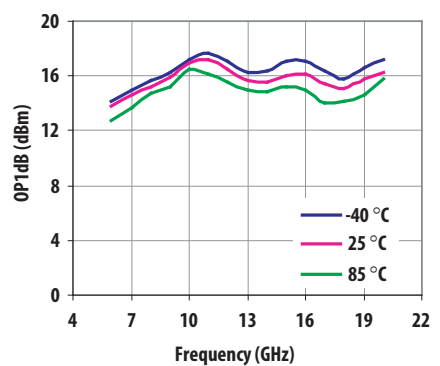

Figure 19. P1dB and Temperature

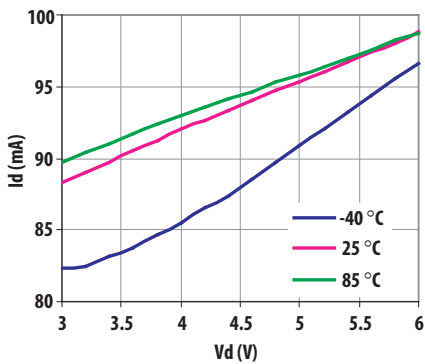

Figure 20. Id vs. Vd

Note: These measurements are obtained using demo board with 50 Ohm traces at input and output. Aspects of the amplifier performance may be improved over a narrower bandwidth by application of additional conjugate, linearity or low noise matching.

Biasing and Operation

The AMMP-5620 only requires a single positive supply connected to the Vd pin (2). The recommended supply voltage is 5V. The supply should be bypassed with a 0.1uF capacitor placed as close to the component as possible. The package base is the RF and DC ground connection. The biasing arrangement is shown in Figure 21.

Figure 22 shows a simplified schematic for the amplifier die. All three stages are self-biased as shown. Each stage has feedback around it to control the gain, match and performance, resulting in excellent wideband performance. Also shown are the on-chip DC blocking capacitors for both the RFin and RFout pins.

Please refer to the Absolute Maximum Ratings table for allowed DC and thermal conditions.

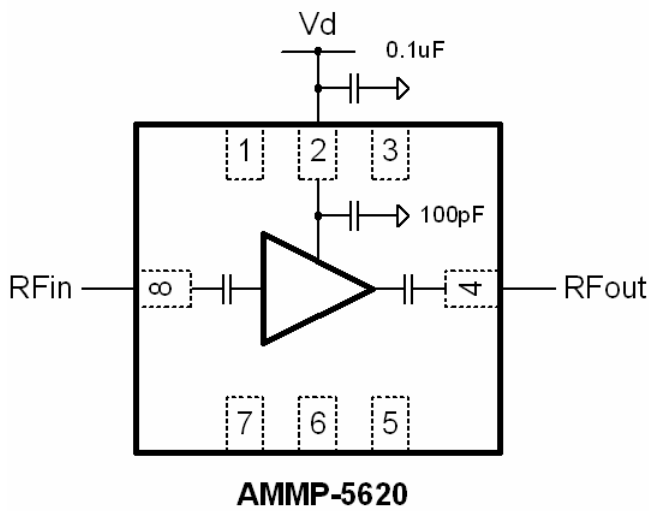

Figure 21. Typical Application

The AMMP Packaged Devices are compatible with high volume surface mount PCB assembly processes.

The PCB material and mounting pattern, as defined in the data sheet, optimizes RF performance and is strongly recommended. An electronic drawing of the land pattern is available upon request from Avago Sales & Application Engineering.

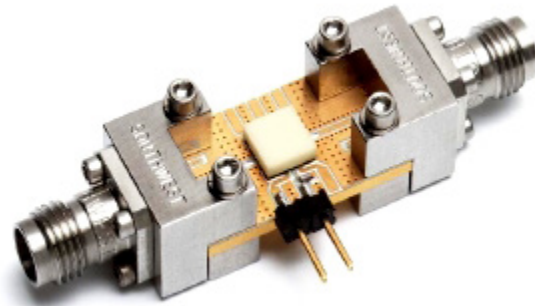

Figure 23. Demonstration Board (available upon request)

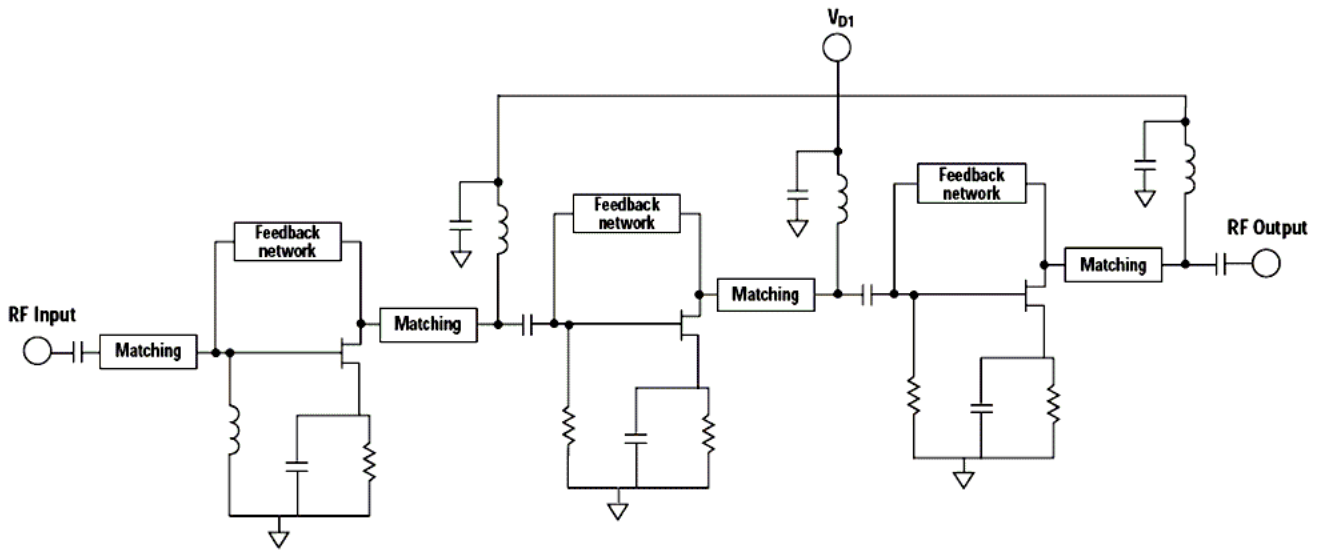

Figure 22. Simplified MMIC Schematics

Typical Scattering Parameters

Please refer to <<http://www.avagotech.com>> for typical scattering parameters data.

Package Dimension, PCB Layout and Tape and Reel information

Please refer to Avago Technologies Application Note 5520, AMxP-xxxx production Assembly Process (Land Pattern A).

Part Number Ordering Information

Part Number	Devices per Container	Container
AMMP-5620-BLKG	10	Antistatic Bag
AMMP-5620-TR1G	100	7" Reel
AMMP-5620-TR2G	500	7" Reel

For product information and a complete list of distributors, please go to our web site: www.avagotech.com

Avago, Avago Technologies, and the A logo are trademarks of Avago Technologies in the United States and other countries. Data subject to change. Copyright © 2005-2013 Avago Technologies. All rights reserved. Obsoletes AV01-0585EN AV02-0513EN - July 16, 2013

