

PVA Short Stroke Key Switches

Features/Benefits

- **Compact design**
- **Short stroke to latch**
- **Wide variety of actuator heights**
- **Adapted for medium power applications**
- **RoHS compliant and compatible**

Typical Applications

- **Automotive (air conditioning, lighting)**
- **Industrial**
- **Control panel**

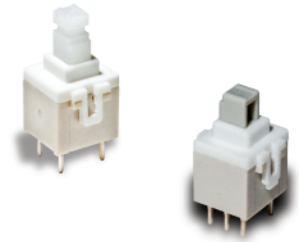

Construction

FUNCTION: Momentary, Push-Push
 CONTACT ARRANGEMENT:
 PVA1: 2 make contacts (DPST)
 PVA2: 2 change over contacts (DPDT)
 SWITCHING MODE: Non-shorting
 TERMINALS: PC pins¹

Mechanical

TOTAL TRAVEL / LATCHING TRAVEL:
 OA: 2,4 mm
 EE: 2,4 / 1,5 mm
 ELECTRICAL TRAVEL: 0.8 mm (1.1 for PVA2 OA H5)
 OPERATING FORCE: 1,2N; 1,7N; 3,5N

Process

SOLDERABILITY:
 Wave soldering, compatible with lead free soldering profile
 Hand soldering, 350°C for 3 seconds

Note: Specifications listed above are for switches with standard options.
 For information on specific and custom switches, please contact technical support using the "Ask a Specialist" option on the PVA product web page.^v

Electrical

SWITCHING POWER MAX.: 3 W DC
 SWITCHING VOLTAGE MAX.: 32 V DC
 SWITCHING CURRENT MAX.: 100 mA DC*
 DIELECTRIC STRENGTH (50 Hz / 1 min):
 1000 V between open contacts, PVA2: 750 V
 OPERATING LIFE:
 OA (momentary): $\geq 1 \times 10^5$ operations
 EE (push-push): $\geq 1 \times 10^5$ operations
 CONTACT RESISTANCE: Initial $\leq 100 \text{ m}\Omega$
 INSULATION RESISTANCE: $\geq 10^{10} \Omega$
 BOUNCE TIME: $\leq 3 \text{ ms}$

Environmental

OPERATING TEMPERATURE: -40°C to 85°C.²

- 1) "Snap-in" contacts on request, Version SNA with pins bent inside (standard)
 2) With button +70°C

How To Order

Our easy build-a-switch concept allows you to mix and match options to create the switch you need. To order, select desired option from each category and place it in the appropriate box. **Some of the configurations may not be available or could require some development.**

Switch

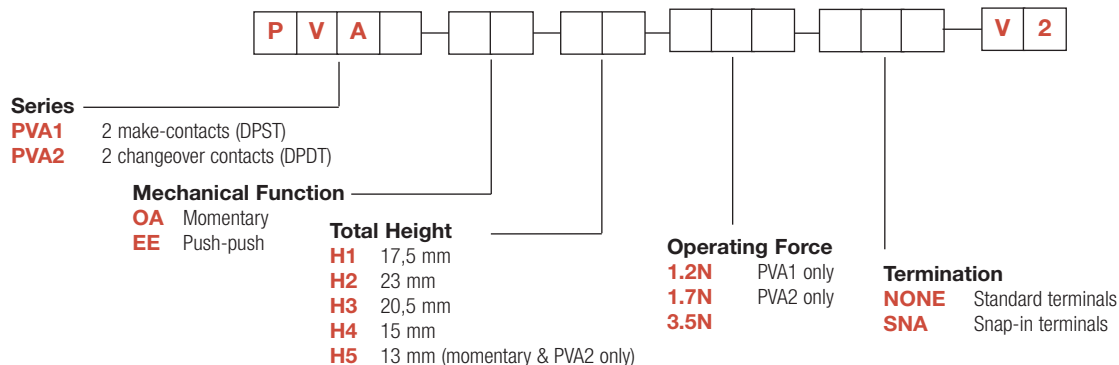

Button

Buttons must be ordered separately.
 Shipped in bulk.

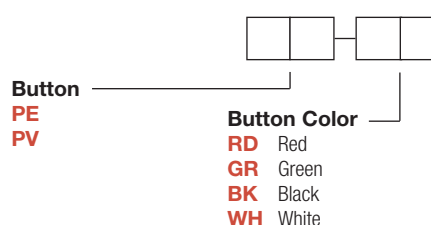

PVA Short Stroke Key Switches

SERIES

PVA1 (DPST)

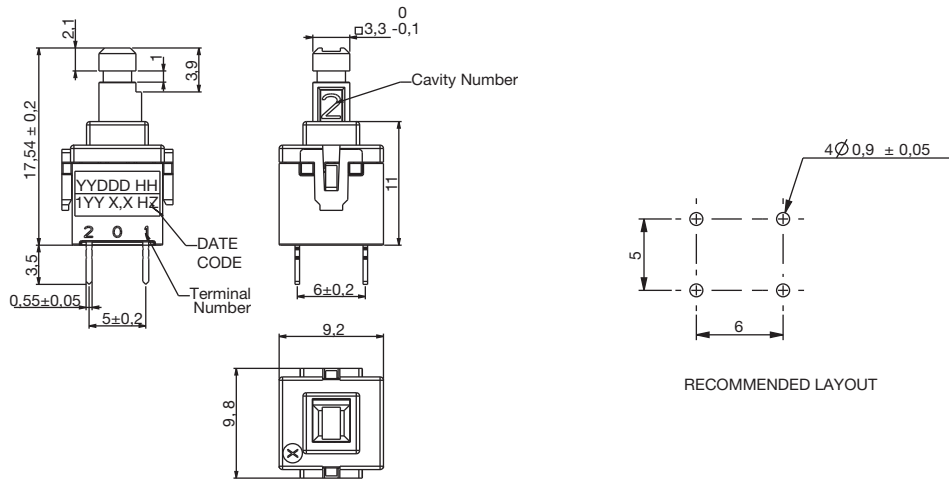

PVA2 (DPDT)

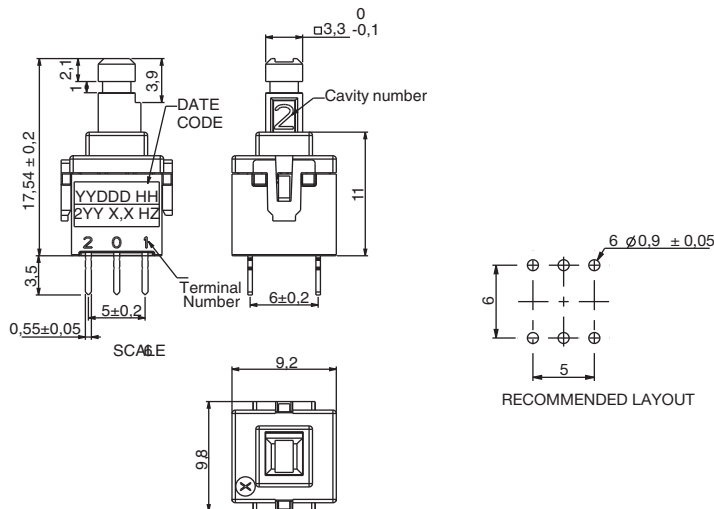

D

Key Switches

MECHANICAL FUNCTION

OPTION CODE	FUNCTION
OA	Momentary
EE	Push-Push

OA

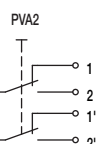
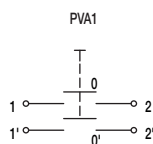

EE

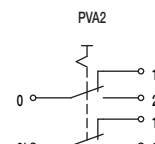
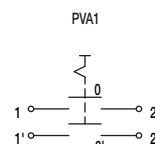

Dimensions are shown: mm
Specifications and dimensions subject to change



PVA Short Stroke Key Switches

TOTAL HEIGHT

H1 17,5 MM

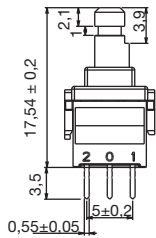

H2 23 MM

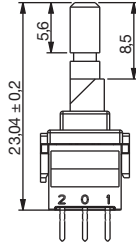

H3 20,5 MM

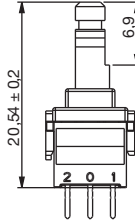

H4 15 MM

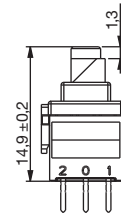

H5 13 MM
(MOMENTARY ONLY)

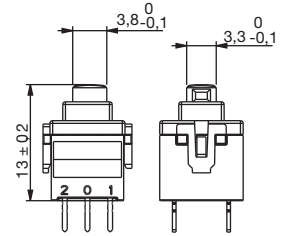

OPERATING FORCE

1.2N PVA1 ONLY
1.7N PVA2 ONLY
3.5N

TERMINATION

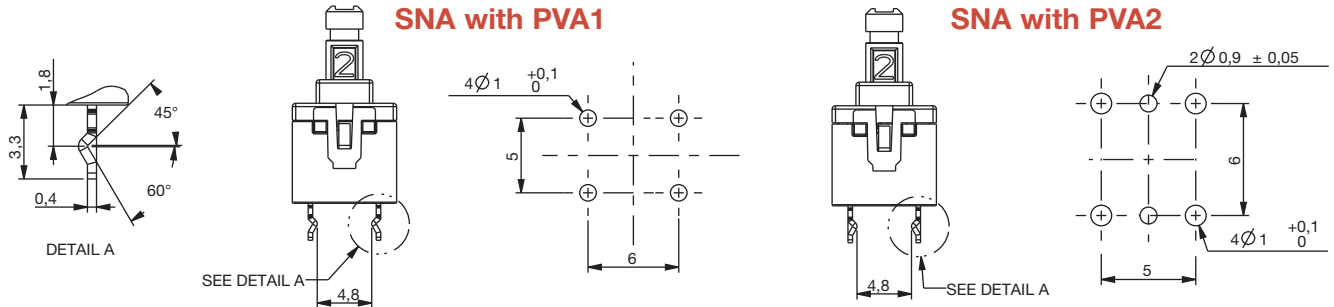

BUTTONS

BUTTONS MUST BE ORDERED SEPARATELY. SHIPPED IN BULK.

PE

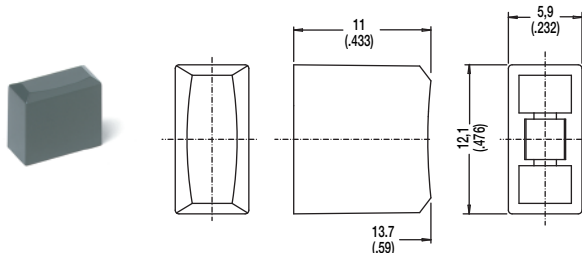

OPTION CODE	COLOR
RD	Red
GY	Gray
BK	Black
WH	White

PV

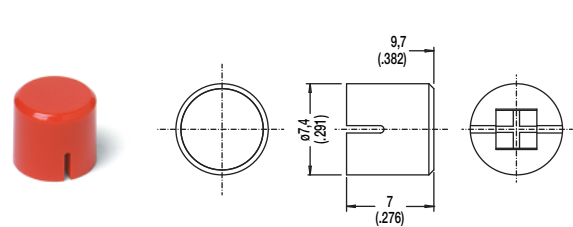

First Angle Projection

Dimensions are shown: mm
Specifications and dimensions subject to change