

### MG12300D-BN3MM Series 300A Dual IGBT



#### Features

- High short circuit capability, self limiting short circuit current
- IGBT CHIP(1200V NPT technology)
- $V_{CE(sat)}$  with positive temperature coefficient
- Fast switching and short tail current
- Free wheeling diodes with fast and soft reverse recovery
- Low switching losses

#### Applications

- Motor drives
- Inverter
- Converter
- SMPS and UPS
- Welder
- Induction Heating

#### Agency Approvals

AGENCY	AGENCY FILE NUMBER
	E71639

#### Module Characteristics ( $T_c = 25^\circ\text{C}$ , unless otherwise specified)

Symbol	Parameters	Test Conditions	Min	Typ	Max	Unit
$T_{J(max)}$	Max. Junction Temperature				150	$^\circ\text{C}$
$T_{J(op)}$	Operating Temperature		-40		125	$^\circ\text{C}$
$T_{stg}$	Storage Temperature		-40		125	$^\circ\text{C}$
$V_{isol}$	Insulation Test Voltage	AC, t=1min		3000		V
CTI	Comparative Tracking Index	Module case exposed to 0.1% ammonium chloride solution per UL and IEC standards	350			V
Torque	Module-to-Sink	Recommended (M6)	3		5	N·m
Torque	Module Electrodes	Recommended (M6)	2.5		5	N·m
Weight				320		g

#### Absolute Maximum Ratings ( $T_c = 25^\circ\text{C}$ , unless otherwise specified)

Symbol	Parameters	Test Conditions	Values	Unit
<b>IGBT</b>				
$V_{CES}$	Collector - Emitter Voltage	$T_J=25^\circ\text{C}$	1200	V
$V_{GES}$	Gate - Emitter Voltage		$\pm 20$	V
$I_C$	DC Collector Current	$T_c=25^\circ\text{C}$	450	A
		$T_c=75^\circ\text{C}$	300	A
$I_{CM}$	Repetitive Peak Collector Current	$t_p=1\text{ms}$	600	A
$P_{tot}$	Power Dissipation Per IGBT		1450	W
<b>Diode</b>				
$V_{RRM}$	Repetitive Reverse Voltage	$T_J=25^\circ\text{C}$	1200	V
$I_{F(AV)}$	Average Forward Current	$T_c=25^\circ\text{C}$	450	A
		$T_c=75^\circ\text{C}$	300	A
$I_{FRM}$	Repetitive Peak Forward Current	$t_p=1\text{ms}$	600	A
$I^2t$		$T_J = 125^\circ\text{C}, t=10\text{ms}, V_R=0\text{V}$	14500	$\text{A}^2\text{s}$

Life Support Note:

#### Not Intended for Use in Life Support or Life Saving Applications

The products shown herein are not designed for use in life sustaining or life saving applications unless otherwise expressly indicated.

### Electrical and Thermal Specifications ( $T_c = 25^\circ\text{C}$ , unless otherwise specified)

Symbol	Parameters	Test Conditions	Min	Typ	Max	Unit
<b>IGBT</b>						
$V_{GE(th)}$	Gate - Emitter Threshold Voltage	$V_{CE}=V_{GE}, I_C=12\text{mA}$	4.5	5.5	6.5	V
$V_{CE(sat)}$	Collector - Emitter Saturation Voltage	$I_C=300\text{A}, V_{GE}=15\text{V}, T_J=25^\circ\text{C}$		3.2		V
		$I_C=300\text{A}, V_{GE}=15\text{V}, T_J=125^\circ\text{C}$		3.85		V
$I_{CES}$	Collector Leakage Current	$V_{CE}=1200\text{V}, V_{GE}=0\text{V}, T_J=25^\circ\text{C}$			2	mA
		$V_{CE}=1200\text{V}, V_{GE}=0\text{V}, T_J=125^\circ\text{C}$			10	mA
$I_{GES}$	Gate Leakage Current	$V_{CE}=0\text{V}, V_{GE}=\pm 15\text{V}, T_J=125^\circ\text{C}$	-400		400	$\mu\text{A}$
$R_{Gint}$	Intergrated Gate Resistor			1.3		$\Omega$
$Q_{ge}$	Gate Charge	$V_{CE}=600\text{V}, I_C=300\text{A}, V_{GE}=\pm 15\text{V}$		3.2		$\mu\text{C}$
$C_{ies}$	Input Capacitance	$V_{CE}=25\text{V}, V_{GE}=0\text{V}, f=1\text{MHz}$		22		nF
$C_{res}$	Reverse Transfer Capacitance			1.0		nF
$t_{d(on)}$	Turn - on Delay Time	Inductive Load $V_{CC}=600\text{V}$ $I_C=300\text{A}$ $R_G=3.3\ \Omega$ $V_{GE}=\pm 15\text{V}$	$T_J=25^\circ\text{C}$		110	ns
			$T_J=125^\circ\text{C}$		120	ns
$t_r$	Rise Time		$T_J=25^\circ\text{C}$		70	ns
			$T_J=125^\circ\text{C}$		80	ns
$t_{d(off)}$	Turn - off Delay Time		$T_J=25^\circ\text{C}$		550	ns
			$T_J=125^\circ\text{C}$		600	ns
$t_f$	Fall Time		$T_J=25^\circ\text{C}$		50	ns
			$T_J=125^\circ\text{C}$		60	ns
$E_{on}$	Turn - on Energy		$T_J=25^\circ\text{C}$		18	mJ
			$T_J=125^\circ\text{C}$		29	mJ
$E_{off}$	Turn - off Energy	$T_J=25^\circ\text{C}$		14	mJ	
		$T_J=125^\circ\text{C}$		22	mJ	
$I_{SC}$	Short Circuit Current	$t_{psc}\leq 10\mu\text{s}, V_{GE}=15\text{V}$ $T_J=125^\circ\text{C}, V_{CC}=900\text{V}$		1200		A
$R_{thJC}$	Junction-to-Case Thermal Resistance (Per IGBT)				0.085	K/W
<b>Diode</b>						
$V_F$	Forward Voltage	$I_F=300\text{A}, V_{GE}=0\text{V}, T_J=25^\circ\text{C}$		2.0		V
		$I_F=300\text{A}, V_{GE}=0\text{V}, T_J=125^\circ\text{C}$		2.05		V
$I_{RRM}$	Max. Reverse Recovery Current	$I_F=300\text{A}, V_R=-600\text{V}$		300		A
$t_{rr}$	Reverse Recovery Time	$d_i/dt=6000\text{A}/\mu\text{s}$		350		ns
$E_{rec}$	Reverse Recovery Energy	$T_J=125^\circ\text{C}$		15.2		mJ
$R_{thJCD}$	Junction-to-Case Thermal Resistance (Per Diode)				0.15	K/W

**Figure 1: Typical Output Characteristics**

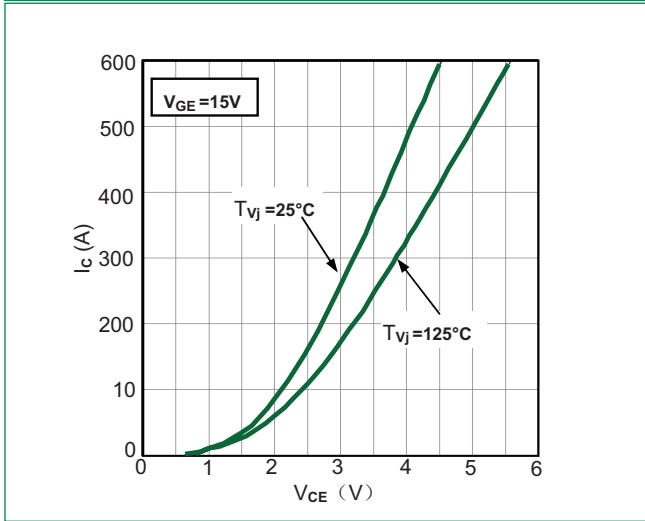

**Figure 2: Typical Output Characteristics**

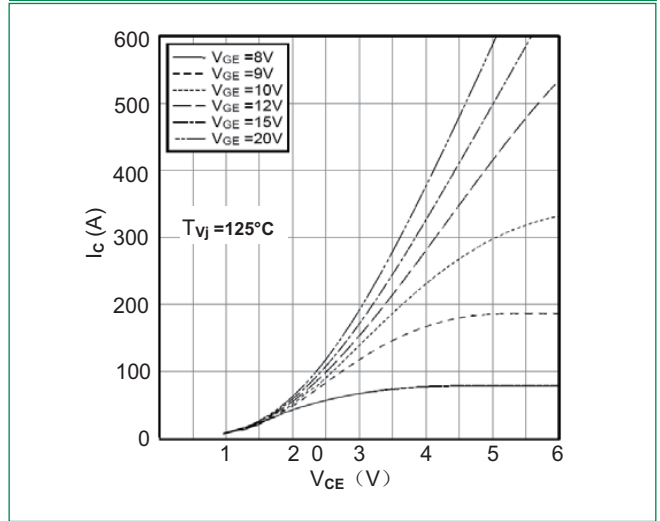

**Figure 3: Typical Transfer characteristics**

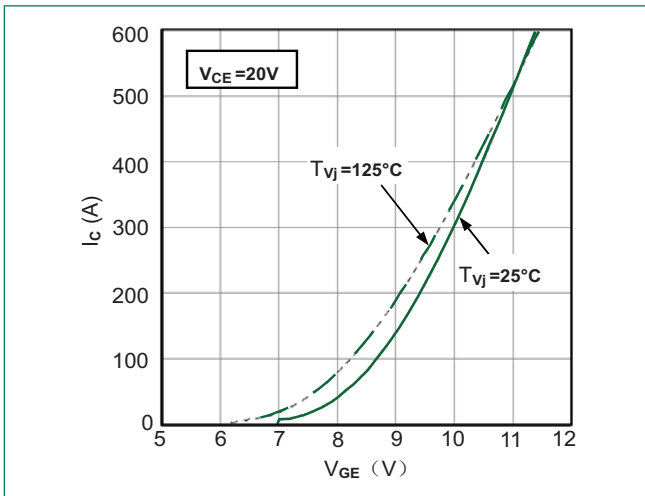

**Figure 4: Switching Energy vs. Gate Resistor**

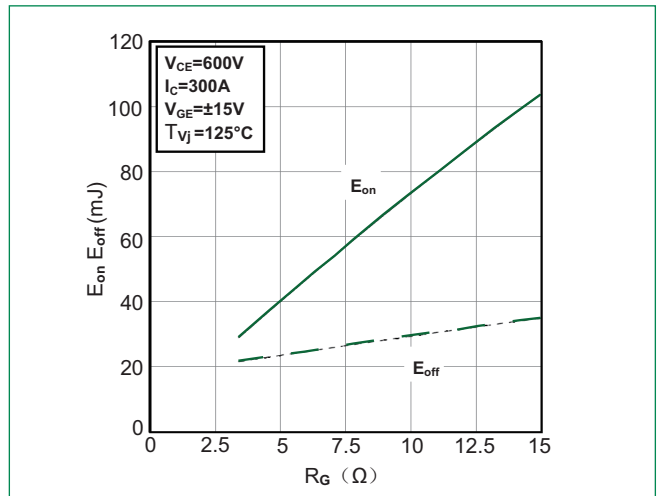

**Figure 5: Switching Energy vs. Collector Current**

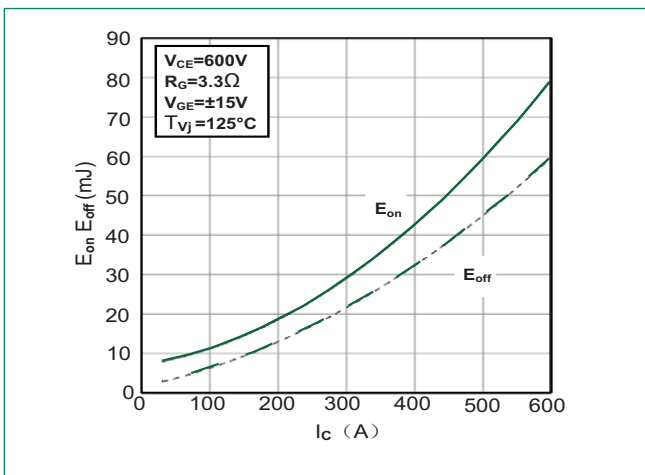

**Figure 6: Reverse Biased Safe Operating Area**

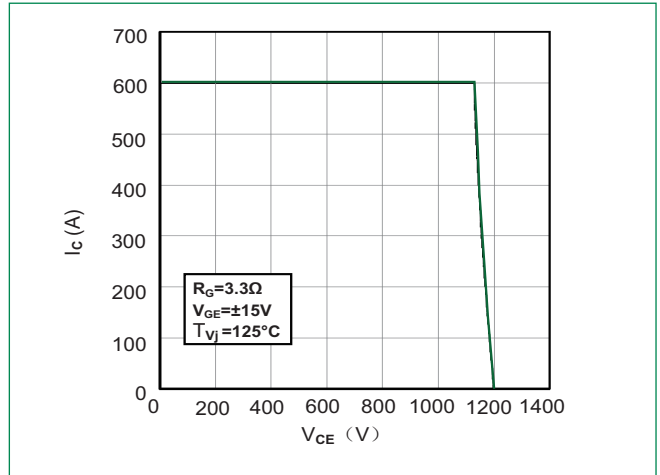

**Figure 7: Diode Forward Characteristics**

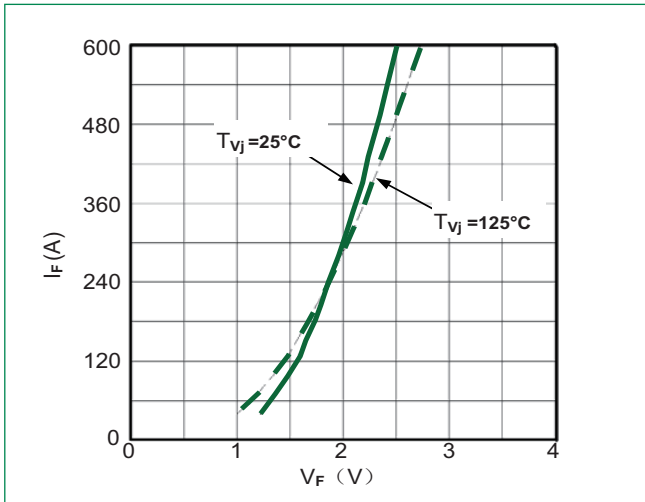

**Figure 8: Switching Energy vs. Gate Resistort**

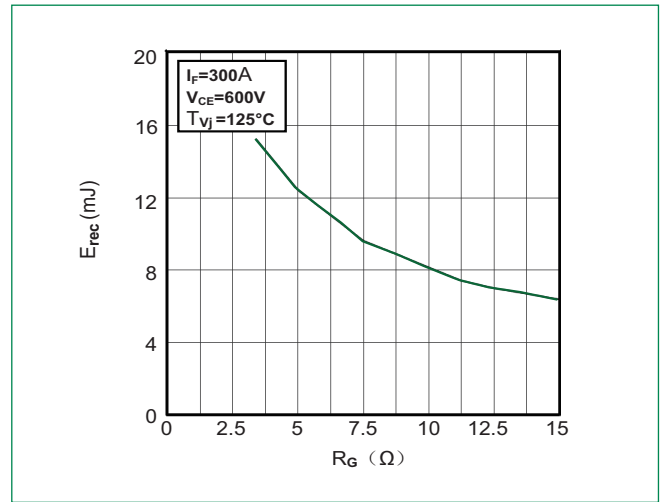

**Figure 9: Switching Energy vs. Forward Current**

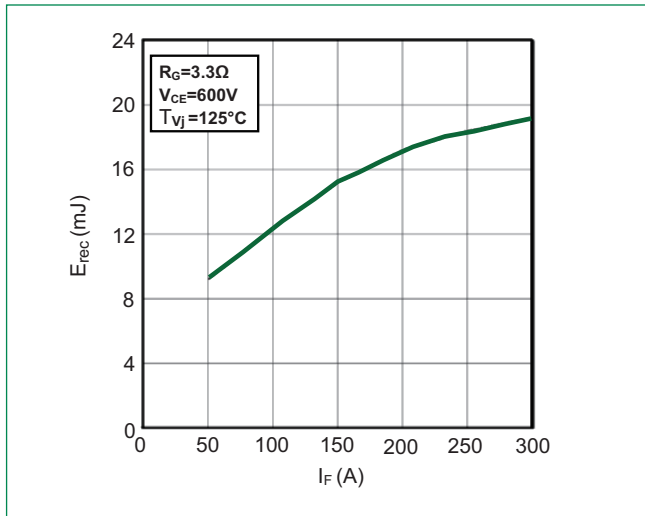

**Figure 10: Transient Thermal Impedance**

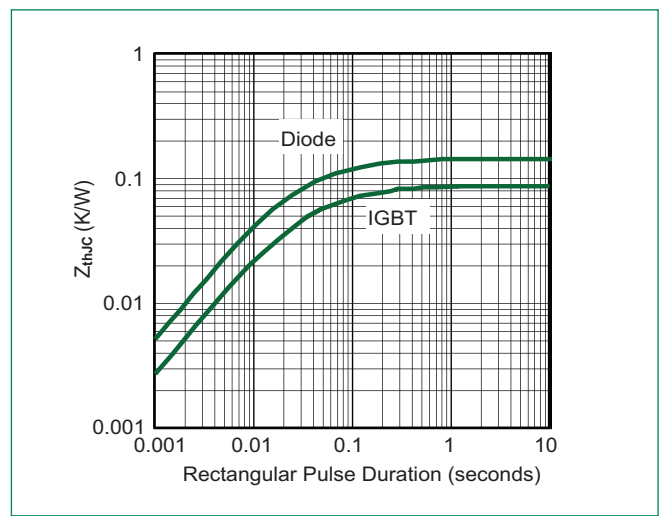

**Dimensions-Package D**

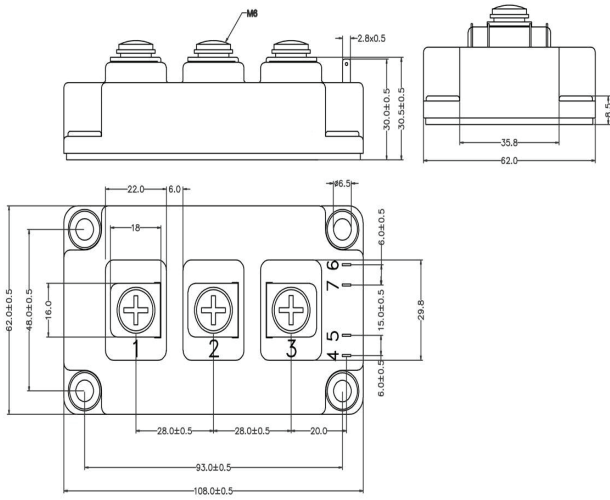

**Circuit Diagram and Pin Assignment**

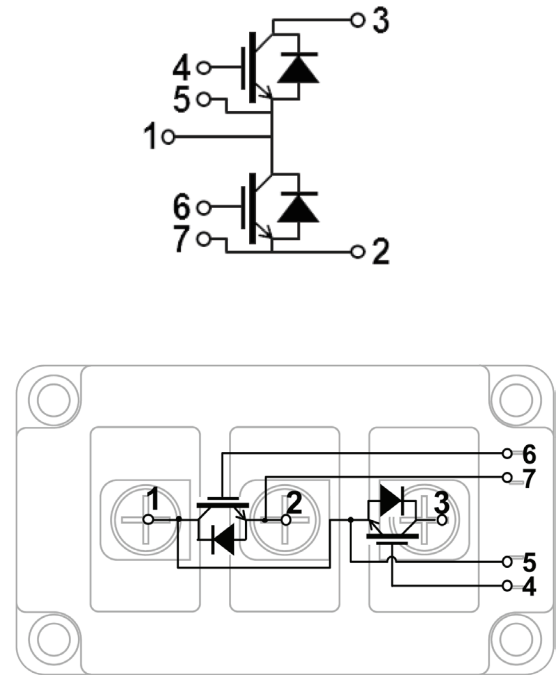

**Packing Options**

Part Number	Marking	Weight	Packing Mode	M.O.Q
MG12300D-BN3MM	MG12300D-BN3MM	320g	Bulk Pack	60

**Part Numbering System**

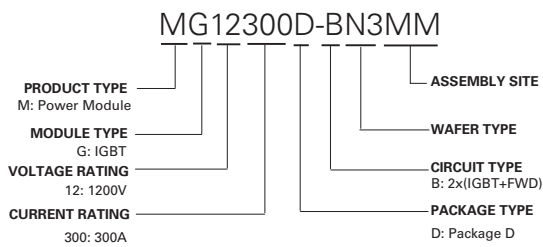

**Part Marking System**

