

Molding Type Module IGBT, 1-in-1 Package, 1200 V and 400 A



Double INT-A-PAK

FEATURES

- High short circuit capability, self limiting to $6 \times I_C$
- 10 μ s short circuit capability
- $V_{CE(on)}$ with positive temperature coefficient
- Low inductance case
- Fast and soft reverse recovery antiparallel FWD
- Isolated copper baseplate using DCB (Direct Copper Bonding) technology
- Material categorization: for definitions of compliance please see www.vishay.com/doc?99912

RoHS
COMPLIANT

PRODUCT SUMMARY	
V_{CES}	1200 V
I_C at $T_C = 80^\circ\text{C}$	400 A
$V_{CE(on)}$ (typical) at $I_C = 400\text{ A}$, 25°C	1.90 V
Speed	8 kHz to 30 kHz
Package	Double INT-A-PAK
Circuit	Single switch with AP diode

TYPICAL APPLICATIONS

- Switching mode power supplies
- AC inverter drives
- Electronic welders at f_{sw} up to 20 kHz

DESCRIPTION

Vishay's IGBT power module provides ultralow conduction loss as well as short circuit ruggedness. It is designed for applications such as inverters and UPS.

ABSOLUTE MAXIMUM RATINGS ($T_C = 25^\circ\text{C}$ unless otherwise noted)				
PARAMETER	SYMBOL	TEST CONDITIONS	MAX.	UNITS
Collector to emitter voltage	V_{CES}		1200	V
Gate to emitter voltage	V_{GES}		± 20	
Collector current at $T_J = 150^\circ\text{C}$	I_C	$T_C = 25^\circ\text{C}$	650	A
		$T_C = 80^\circ\text{C}$	400	
Pulsed collector current	$I_{CM}^{(1)}$	$T_C = 80^\circ\text{C}$	800	
Diode continuous forward current	I_F		400	
Diode maximum forward current	I_{FM}		800	
Maximum power dissipation	P_D	$T_J = 150^\circ\text{C}$	2500	
Short circuit withstand time	t_{SC}	$T_J = 125^\circ\text{C}$	10	μ s
I^2t -value, diode	I^2t	$V_R = 0\text{ V}$, $t = 10\text{ ms}$, $T_J = 125^\circ\text{C}$	27 500	A^2s
RMS isolation voltage	V_{ISOL}	$f = 50\text{ Hz}$, $t = 1\text{ min}$	2500	V

Note

(1) Repetitive rating; pulse width limited by maximum junction temperature.



IGBT ELECTRICAL SPECIFICATIONS ($T_C = 25\text{ }^\circ\text{C}$ unless otherwise noted)						
PARAMETER	SYMBOL	TEST CONDITIONS	MIN.	TYP.	MAX.	UNITS
Collector to emitter breakdown voltage	$V_{(BR)CES}$	$T_J = 25\text{ }^\circ\text{C}$	1200	-	-	V
Collector to emitter saturation voltage	$V_{CE(on)}$	$V_{GE} = 15\text{ V}, I_C = 400\text{ A}, T_J = 25\text{ }^\circ\text{C}$	-	1.9	-	
		$V_{GE} = 15\text{ V}, I_C = 400\text{ A}, T_J = 125\text{ }^\circ\text{C}$	-	2.1	-	
Gate to emitter threshold voltage	$V_{GE(th)}$	$V_{CE} = V_{GE}, I_C = 8\text{ mA}, T_J = 25\text{ }^\circ\text{C}$	5.0	6.2	7.0	
Zero gate voltage collector current	I_{CES}	$V_{CE} = V_{CES}, V_{GE} = 0\text{ V}, T_J = 25\text{ }^\circ\text{C}$	-	-	5.0	mA
Gate to emitter leakage current	I_{GES}	$V_{GE} = V_{GES}, V_{CE} = 0\text{ V}, T_J = 25\text{ }^\circ\text{C}$	-	-	400	nA

SWITCHING CHARACTERISTICS						
PARAMETER	SYMBOL	TEST CONDITIONS	MIN.	TYP.	MAX.	UNITS
Turn-on delay time	$t_{d(on)}$	$V_{CC} = 600\text{ V}, I_C = 400\text{ A}, R_g = 4\text{ }\Omega, V_{GE} = \pm 15\text{ V}, T_J = 25\text{ }^\circ\text{C}$	-	100	-	ns
Rise time	t_r		-	60	-	
Turn-off delay time	$t_{d(off)}$		-	420	-	
Fall time	t_f		-	60	-	
Turn-on switching loss	E_{on}	$V_{CC} = 600\text{ V}, I_C = 400\text{ A}, R_g = 4\text{ }\Omega, V_{GE} = \pm 15\text{ V}, T_J = 125\text{ }^\circ\text{C}$	-	33	-	mJ
Turn-off switching loss	E_{off}		-	42	-	
Turn-on delay time	$t_{d(on)}$		-	120	-	
Rise time	t_r		-	60	-	
Turn-off delay time	$t_{d(off)}$	$V_{CC} = 600\text{ V}, I_C = 400\text{ A}, R_g = 4\text{ }\Omega, V_{GE} = \pm 15\text{ V}, T_J = 125\text{ }^\circ\text{C}$	-	490	-	ns
Fall time	t_f		-	75	-	
Turn-on switching loss	E_{on}		-	35	-	
Turn-off switching loss	E_{off}		-	46	-	
Input capacitance	C_{ies}	$V_{GE} = 0\text{ V}, V_{CE} = 25\text{ V}, f = 1.0\text{ MHz}$	-	30	-	nF
Output capacitance	C_{oes}		-	4	-	
Reverse transfer capacitance	C_{res}		-	3	-	
SC data	I_{SC}	$t_{sc} \leq 10\text{ }\mu\text{s}, V_{GE} = 15\text{ V}, T_J = 125\text{ }^\circ\text{C}, V_{CC} = 900\text{ V}, V_{CEM} \leq 1200\text{ V}$	-	1900	-	A
Stray inductance	L_{CE}		-	-	20	nH
Module lead resistance, terminal to chip	$R_{CC'+EE'}$	$T_C = 25\text{ }^\circ\text{C}$	-	0.18	-	m Ω

DIODE ELECTRICAL SPECIFICATIONS ($T_C = 25\text{ }^\circ\text{C}$ unless otherwise noted)							
PARAMETER	SYMBOL	TEST CONDITIONS	MIN.	TYP.	MAX.	UNITS	
Diode forward voltage	V_F	$I_F = 400\text{ A}$	$T_J = 25\text{ }^\circ\text{C}$	-	2.1	2.2	V
			$T_J = 125\text{ }^\circ\text{C}$	-	2.2	2.3	
Diode reverse recovery charge	Q_{rr}	$I_F = 400\text{ A}, V_R = 600\text{ V}, dI/dt = -4000\text{ A}/\mu\text{s}, V_{GE} = -15\text{ V}$	$T_J = 25\text{ }^\circ\text{C}$	-	40	-	μC
			$T_J = 125\text{ }^\circ\text{C}$	-	48	-	
Diode peak reverse recovery current	I_{rr}	$I_F = 400\text{ A}, V_R = 600\text{ V}, dI/dt = -4000\text{ A}/\mu\text{s}, V_{GE} = -15\text{ V}$	$T_J = 25\text{ }^\circ\text{C}$	-	320	-	A
			$T_J = 125\text{ }^\circ\text{C}$	-	400	-	
Diode reverse recovery energy	E_{rec}	$I_F = 400\text{ A}, V_R = 600\text{ V}, dI/dt = -4000\text{ A}/\mu\text{s}, V_{GE} = -15\text{ V}$	$T_J = 25\text{ }^\circ\text{C}$	-	12	-	mJ
			$T_J = 125\text{ }^\circ\text{C}$	-	20	-	



THERMAL AND MECHANICAL SPECIFICATIONS						
PARAMETER	SYMBOL	TEST CONDITIONS	MIN.	TYP.	MAX.	UNITS
Operating junction temperature range	T_J		-40	-	150	°C
Storage temperature range	T_{Stg}		-40	-	125	
Junction to case per module	IGBT	R_{thJC}	-	-	0.05	K/W
	Diode		-	-	0.09	
Case to sink	R_{thCS}	Conductive grease applied	-	0.035	-	
Mounting torque		Power terminal screw: M6	2.5 to 5.0			Nm
		Mounting screw: M6	3.0 to 6.0			
Weight			310			g

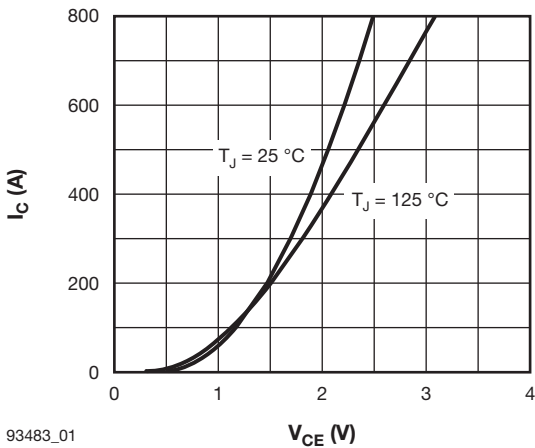

Fig. 1 - Typical Output Characteristics
 $V_{GE} = 15\text{ V}$

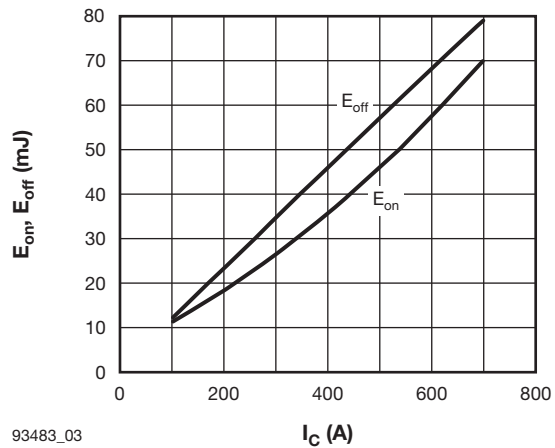

Fig. 3 - Switching Loss vs. Collector Current
 $V_{CC} = 600\text{ V}$, $R_g = 4\ \Omega$, $V_{GE} = \pm 15\text{ V}$, $T_J = 125\text{ }^\circ\text{C}$

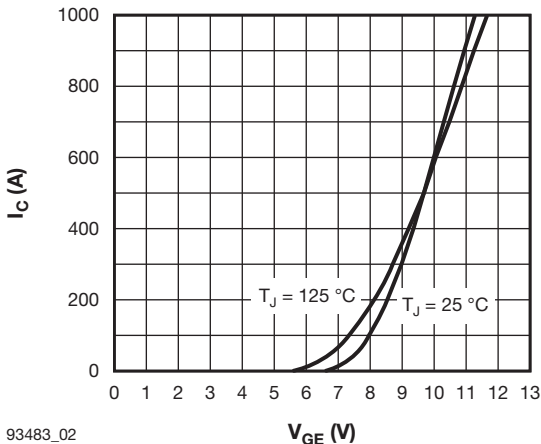

Fig. 2 - Typical Transfer Characteristics
 $V_{CE} = 20\text{ V}$

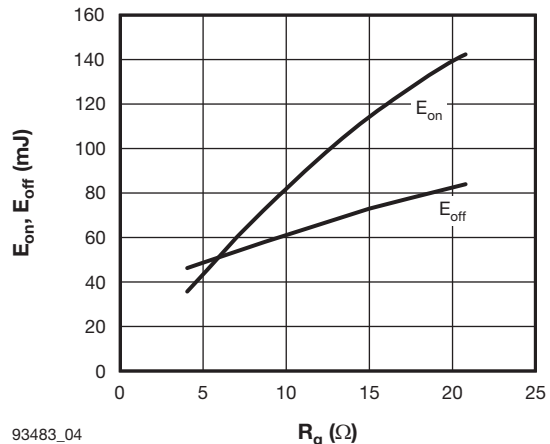
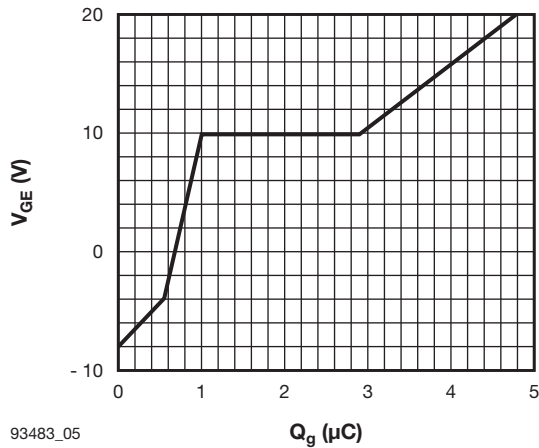
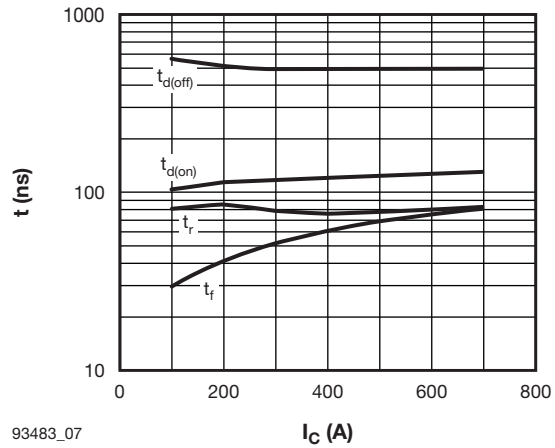

Fig. 4 - Switching Loss vs. Gate Resistor
 $V_{CC} = 600\text{ V}$, $I_C = 400\text{ A}$, $V_{GE} = \pm 15\text{ V}$, $T_J = 125\text{ }^\circ\text{C}$



93483_05

Fig. 5 - Gate Charge Characteristics
 $V_{CC} = 600\text{ V}$, $I_C = 400\text{ A}$, $T_J = 25\text{ }^\circ\text{C}$



93483_07

Fig. 7 - Typical Switching Times vs. I_C
 $V_{CC} = 600\text{ V}$, $R_g = 4\text{ }\Omega$, $V_{GE} = \pm 15\text{ V}$, $T_J = 125\text{ }^\circ\text{C}$

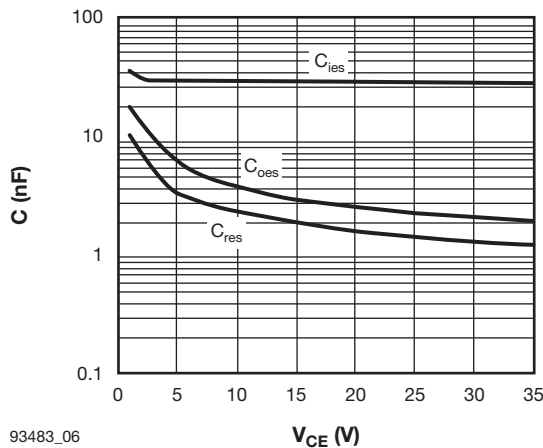

93483_06

Fig. 6 - Typical Capacitance vs. Collector to Emitter Voltage

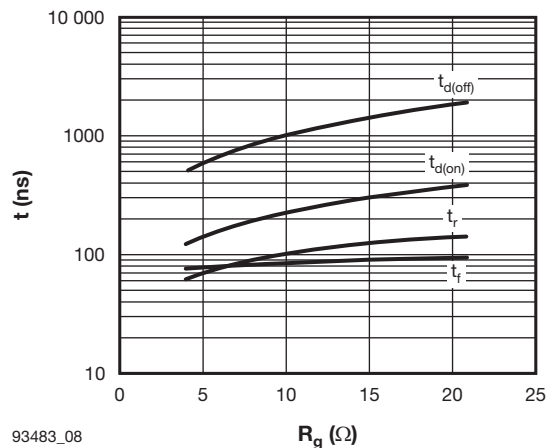

93483_08

Fig. 8 - Typical Switching Times vs. Gate Resistance
 $V_{CC} = 600\text{ V}$, $I_C = 400\text{ A}$, $V_{GE} = \pm 15\text{ V}$, $T_J = 125\text{ }^\circ\text{C}$

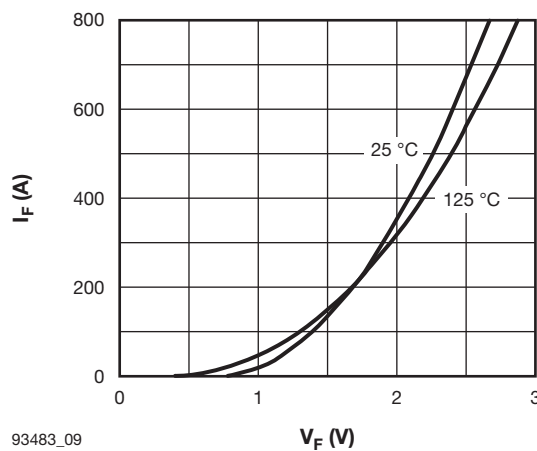

93483_09

Fig. 9 - Typical Forward Characteristics (Diode)

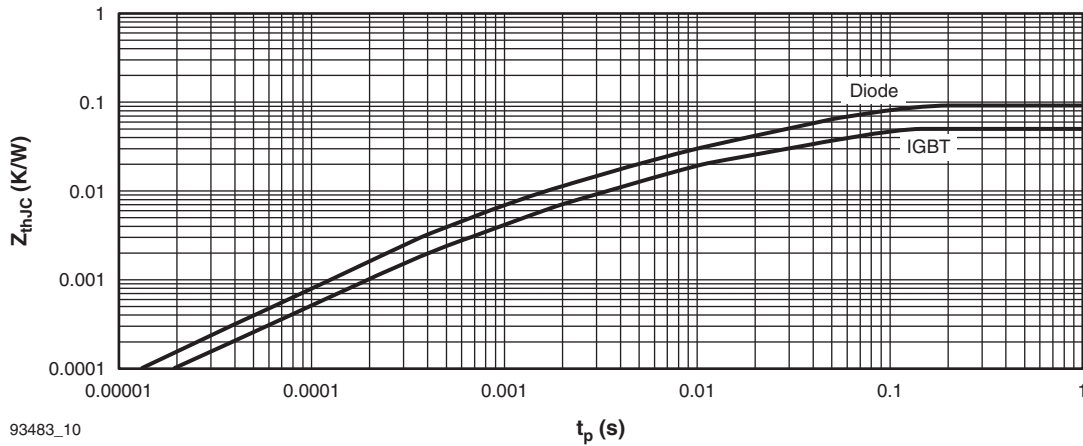
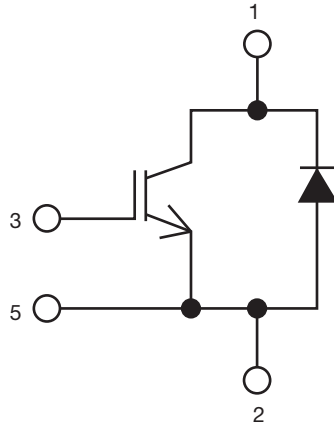

Fig. 10 - Transient Thermal Impedance

CIRCUIT CONFIGURATION



LINKS TO RELATED DOCUMENTS	
Dimensions	www.vishay.com/doc?95526



Double INT-A-PAK

DIMENSIONS in millimeters (inches)

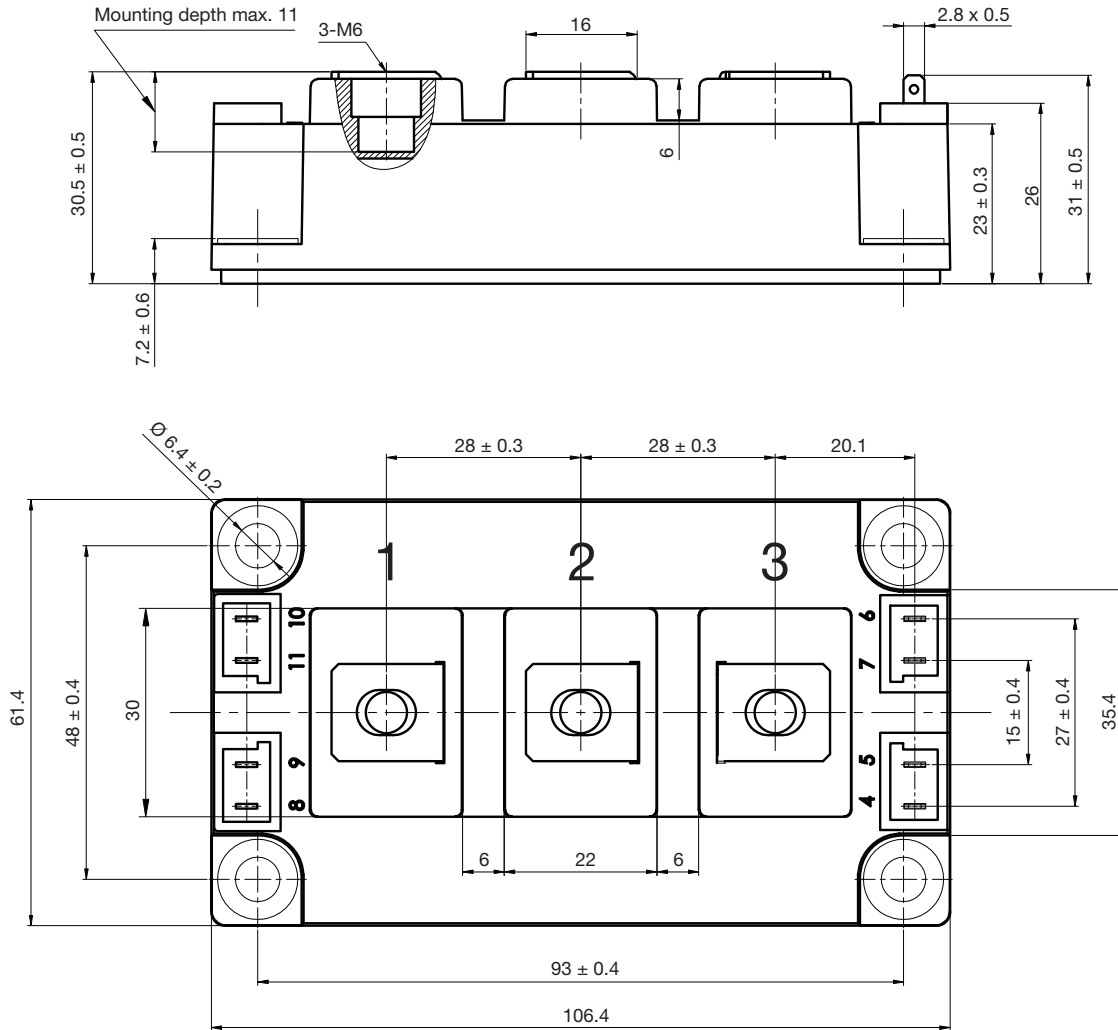



Disclaimer

ALL PRODUCT, PRODUCT SPECIFICATIONS AND DATA ARE SUBJECT TO CHANGE WITHOUT NOTICE TO IMPROVE RELIABILITY, FUNCTION OR DESIGN OR OTHERWISE.

Vishay Intertechnology, Inc., its affiliates, agents, and employees, and all persons acting on its or their behalf (collectively, "Vishay"), disclaim any and all liability for any errors, inaccuracies or incompleteness contained in any datasheet or in any other disclosure relating to any product.

Vishay makes no warranty, representation or guarantee regarding the suitability of the products for any particular purpose or the continuing production of any product. To the maximum extent permitted by applicable law, Vishay disclaims (i) any and all liability arising out of the application or use of any product, (ii) any and all liability, including without limitation special, consequential or incidental damages, and (iii) any and all implied warranties, including warranties of fitness for particular purpose, non-infringement and merchantability.

Statements regarding the suitability of products for certain types of applications are based on Vishay's knowledge of typical requirements that are often placed on Vishay products in generic applications. Such statements are not binding statements about the suitability of products for a particular application. It is the customer's responsibility to validate that a particular product with the properties described in the product specification is suitable for use in a particular application. Parameters provided in datasheets and / or specifications may vary in different applications and performance may vary over time. All operating parameters, including typical parameters, must be validated for each customer application by the customer's technical experts. Product specifications do not expand or otherwise modify Vishay's terms and conditions of purchase, including but not limited to the warranty expressed therein.

Except as expressly indicated in writing, Vishay products are not designed for use in medical, life-saving, or life-sustaining applications or for any other application in which the failure of the Vishay product could result in personal injury or death. Customers using or selling Vishay products not expressly indicated for use in such applications do so at their own risk. Please contact authorized Vishay personnel to obtain written terms and conditions regarding products designed for such applications.

No license, express or implied, by estoppel or otherwise, to any intellectual property rights is granted by this document or by any conduct of Vishay. Product names and markings noted herein may be trademarks of their respective owners.