



PART No. EN4TD364812LG

for more information visit
www.hammfg.com

Data subject to change without notice

Isometric drawing Not to Scale

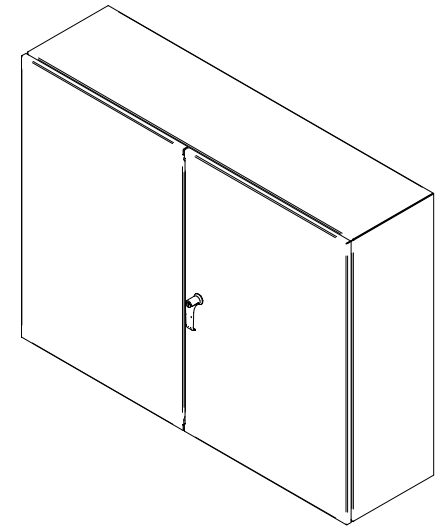

ISOMETRIC VIEW

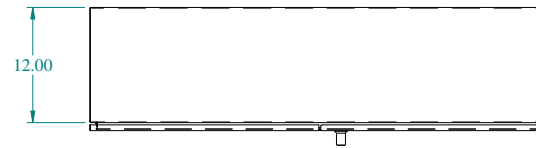

TOP VIEW

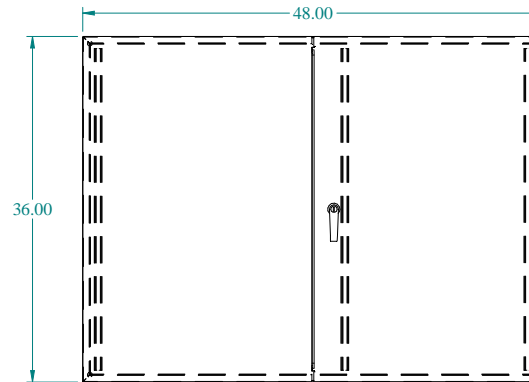

FRONT VIEW

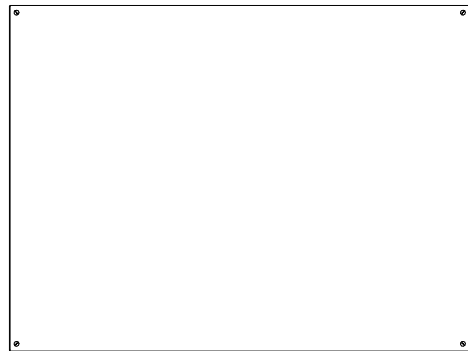

BACK VIEW

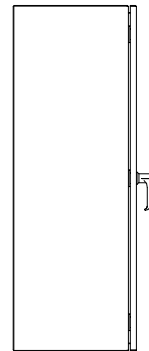

LEFT SIDE VIEW

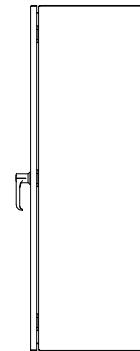

RIGHT SIDE VIEW

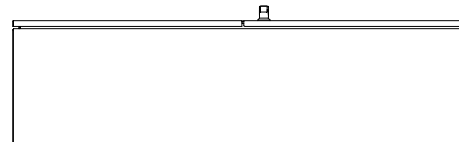

BOTTOM VIEW