

# USB mini B jack 90° PCB mount

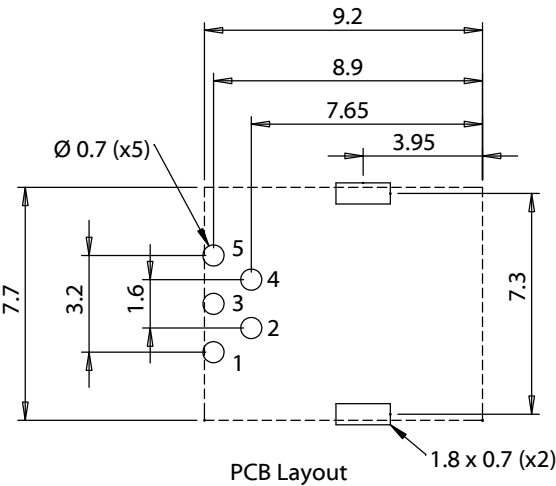
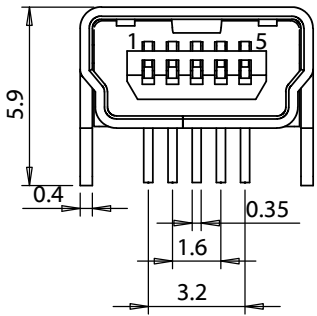
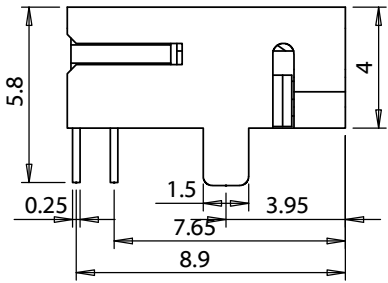
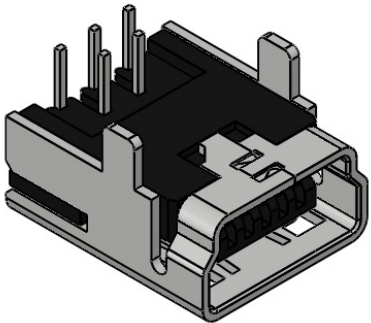
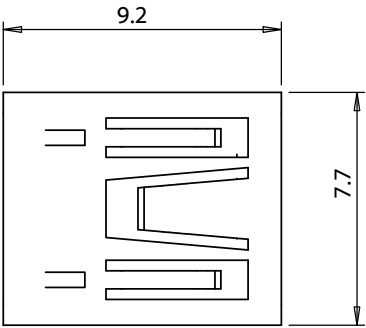

DIMENSIONS ARE IN MILLIMETERS  
 TOLERANCES:  
 Up to 1.0: ± 0.1 mm  
 1.0 to 10.0: ± 0.2 mm  
 Over 10.0: ± 0.3 mm

NOTES  
 RoHS and REACH compliant

DESCRIPTION:  
 Connector, USB mini B Jack, PCB mount, 90°, nickel shell, DIP, black insulator, tube

**TENSILITY**  
 20802 Sockeye Place #130  
 Bend, OR 97701 USA  
 tel 541.323.3228 fax 541.323.4202  
 800 877.670.7118 www.tensility.com

SIZE	PART NUMBER
A	54-00019
SCALE: 1:1	SHEET 1 OF 2

**Materials**

1. Shell, phosphor bronze, nickel plated
2. Pins, phosphor bronze, 5 μ" gold and tin plating
3. Insulator, Nylon 46, black

**Electrical**

Rated voltage: 30 Vdc  
 Rated current: 2 A  
 Dielectric strength: 1 min @ 500 Vac  
 Insulation resistance: 100 MΩ @ 500 Vdc  
 Contact resistance: 50 mΩ or less

**Mechanical**

Insertion force: 3.5 kgf maximum  
 Withdrawal force: 0.7 kgf minimum  
 Durability: 5000 cycle minimum life; less than 100 mΩ contact resistance, minimum 50 MΩ insulation resistance  
 Terminal strength: 0.3 kgf in any direction without damage or looseness

**Soldering**

Solderability: 75% minimum coverage when terminals dipped 2 mm in 255 ±5 °C solder bath for 3 ±0.5 seconds  
 Solder bath durability: no deformation when immersed in 260 ±5 °C up to surface of the board for 10 seconds or less  
 Solder iron durability: no deformation when exposed to 350 ±10 °C for 3 ±0.5 seconds

**Environmental**

Cold test: -25 ±3 °C for 48 hours without deformation  
 Heat test: 70 ±2 °C for 48 hours without deformation  
 Humidity test: 40 ±2 °C and humidity between 90 and 98 % for 48 hours without deformation

**Operating range**

-10 ~ 60 °C

# USB mini B jack 90° PCB mount

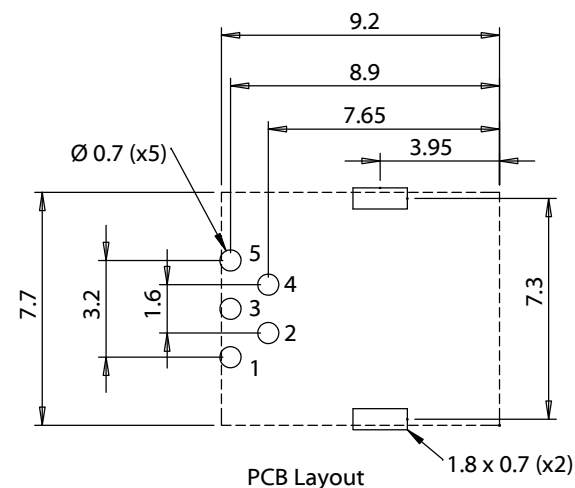
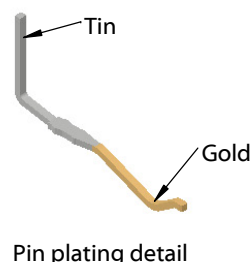
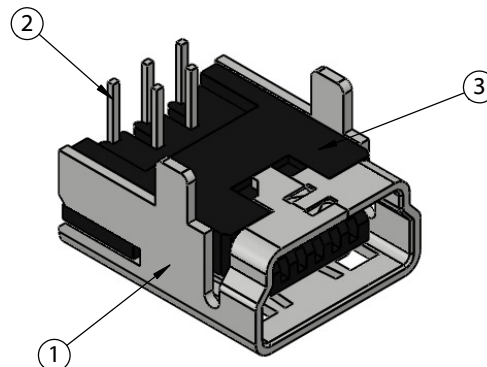

REVISION	DATE	DESCRIPTION	PREPARED:	NOTES RoHS and REACH compliant	<h1 style="margin: 0;">TENSILITY</h1> <p style="margin: 5px 0 0 0; font-size: small;">20802 Sockeye Place #130            Bend, OR 97701 USA            tel 541.323.3228 fax 541.323.4202            800 877.670.7118 www.tensility.com</p>		
A	9/28/2015	Initial release					
			VERIFIED:				
			DIMENSIONS ARE IN MILLIMETERS				
			TOLERANCES: Up to 1.0: ± 0.1 mm 1.0 to 10.0: ± 0.2 mm Over 10.0: ± 0.3 mm	DESCRIPTION: Connector, USB mini B Jack, PCB mount, 90°, nickel shell, DIP, black insulator, tube	SIZE A	PART NUMBER 54-00019	
					SCALE: 1:1		SHEET 2 OF 2