

**Dimensions mm[inch]**  
 tolerances acc. to DIN ISO 2768-m  
 Toleranzen gem. DIN ISO 2768-m

**Isometric**  
 Scale 1:2  
 Maßstab 1:2

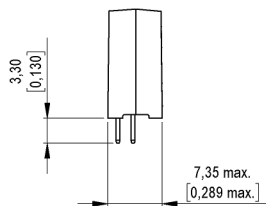

**Marking**  
 according to EN60062/Factory code  
 gem. EN60062/Fertigungsstätte

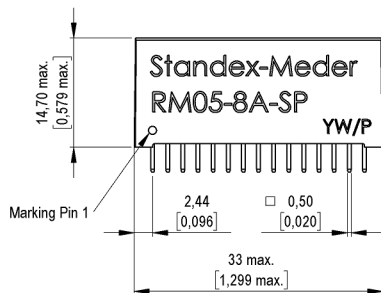
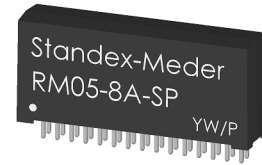
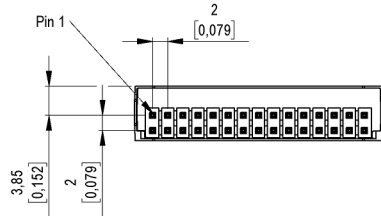
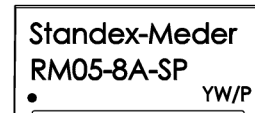

**Recommended Matrix Layout**

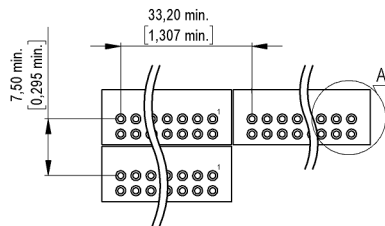

**Recommended PCB Pad Layout**

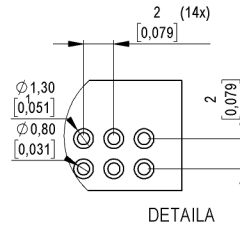

**Block diagram**

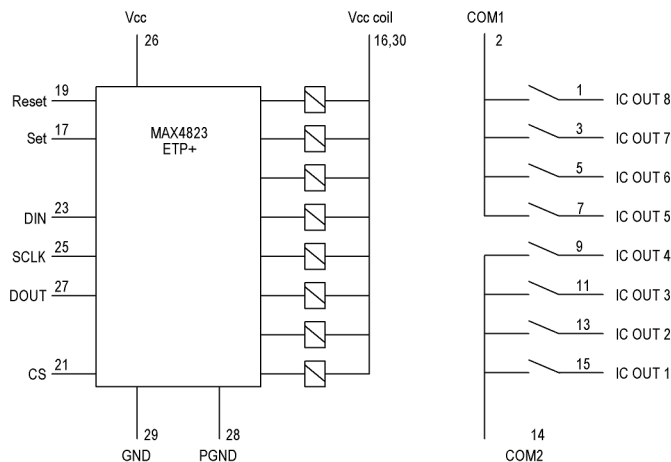



Europe: +49 / 7731 8399 0

| Email: info@standexmeder.com

Item No.:

USA: +1 / 508 295 0771

| Email: salesusa@standexmeder.com

**9605080022**

Asia: +852 / 2955 1682

| Email: salesasia@standexmeder.com

Item:

**RM05-8A-SP**

Coil Data at 20 °C	Conditions	Min	Typ	Max	Unit
Coil resistance		450	500	550	Ohm
Nominal voltage			5		VDC
Operating voltage		4,75	5	5,25	VDC
Coil current		9	10	11	mA

Contact data 80	Conditions	Min	Typ	Max	Unit
Contact-rating	Any DC combination of V & A not to exceed their individual max.'s			10	W
Switching voltage	DC or Peak AC			100	V
Switching current	DC or Peak AC			0,5	A
Carry current	DC or Peak AC			0,5	A
Contact resistance static	Measured with 40% overdrive Start Value			200	mOhm
Insulation resistance	RH <45 %, 100 V test voltage	1			GOhm
Breakdown voltage	according to EN 60255-5	210			VDC
Operate time incl. bounce	measured with 40% overdrive			0,3	ms
Capacitance	@ 10 kHz above open switch		0,1		pF

Special Product Data	Conditions	Min	Typ	Max	Unit
Standby current			0,1		mA
Number of contacts			8		
Dielectric Strength Coil/Contact	according to EN 60255-5	1,5			kV DC
Insulation resistance Coil/Contact	RH <45%, 200 VDC Measuring Voltage	100			GOhm
Capacity Coil/Contact	@ 10 kHz		0,2		pF
Housing material			Epoxy		
Material connection pads			Phosphor Bronze (tinned)		
Magnetic Shield			yes		
Reach / RoHS conformity			yes		
Remarks			IC= 8-Kanal relay driver MAX4823		

Environmental data	Conditions	Min	Typ	Max	Unit
Operating temperature		-20		85	°C
Storage temperature		-35		100	°C
Soldering Temperature Tsold	Reflow acc.IPC/JEDEC J-STD-020D.1			260	°C
Washability			fully sealed		

General data	Conditions	Min	Typ	Max	Unit
Packaging			ESD-Blister per 10 pcs.		

Modifications in the sense of technical progress are reserved

Designed at: 22.07.15 Designed by: THAUKE

Approval at: 12.10.16 Approval by: THAUKE

Last Change at: 25.08.17 Last Change by: THAUKE

Approval at: 28.08.17 Approval by: DSTASTNY

Version: 3