

NCP59300, NCV59300 Series

3.0 A, Very Low-Dropout (VLDO) Fast Transient Response Regulator series

The NCP59300 series are high precision, very low dropout (VLDO), low ground current positive voltage regulators that are capable of providing an output current in excess of 3.0 A with a typical dropout voltage lower than 300 mV at 3.0 A load current. The devices are stable with ceramic output capacitors. This series consists of fixed voltage versions.

The NCP59300 series can withstand up to 18 V max input voltage.

Internal protection features consist of output current limiting, built-in thermal shutdown and reverse output current protection. Logic level enable and error flag pins are available on the 5-pin version.

The NCP59300 series fixed voltage devices are available in D2PAK-5 package, with devices in D2PAK-3 package planned in the future.

Features

- Output Current in Excess of 3.0 A
- 300 mV Typical Dropout Voltage at 3.0 A
- Fixed Output Voltage Options
- Low Ground Current
- Fast Transient Response
- Stable with Ceramic Output Capacitor
- Logic Compatible Enable and Error Flag Pins
- Current Limit, Reverse Current and Thermal Shutdown Protection
- Operation up to 13.5 V Input Voltage
- NCV Prefix for Automotive and Other Applications Requiring Unique Site and Control Change Requirements; AEC-Q100 Qualified and PPAP Capable
- These are Pb-Free Devices

Applications

- Consumer and Industrial Equipment Point of Regulation
- Servers and Networking Equipment
- FPGA, DSP and Logic Power supplies
- Switching Power Supply Post Regulation
- Battery Chargers
- Functional Replacement for Industry Standard MIC29300, MIC39300, MIC37300 Fixed Voltage Devices



ON Semiconductor®

<http://onsemi.com>

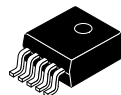

D²PAK 5
CASE 936A

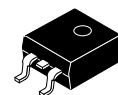

D²PAK
CASE 936

MARKING DIAGRAMS

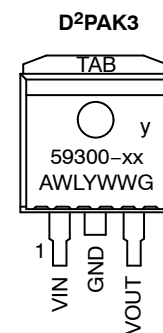
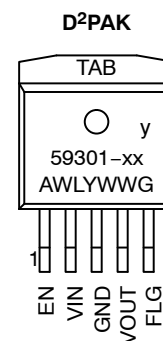

xx = Voltage Version
y = P (NCP), V (NCV)
A = Assembly Location
WL = Wafer Lot
Y = Year
WW = Work Week
G = Pb-Free Package

ORDERING INFORMATION

See detailed ordering and shipping information in the package dimensions section on page 8 of this data sheet.

NCP59300, NCV59300 Series

TYPICAL APPLICATIONS

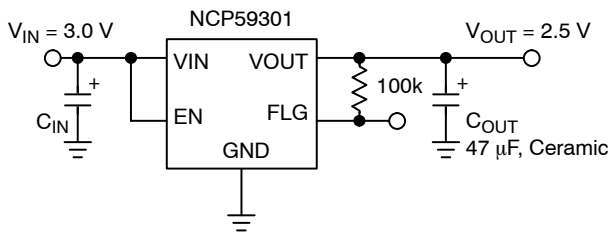

Figure 1. Fixed 2.5 V Regulator with Error Flag

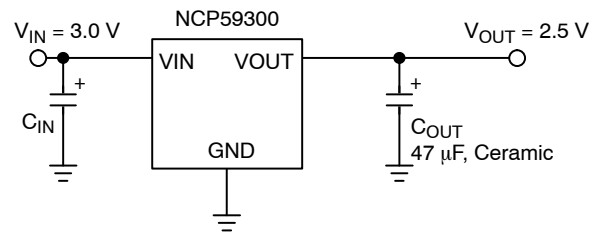

Figure 2. Fixed 2.5 V Regulator in D²PAK-3 Package

PIN FUNCTION DESCRIPTION

Pin Number D2PAK-5	Pin Number D2PAK-3	Pin Name	Pin Function
1	-	EN	Enable Input: CMOS and TTL logic compatible. Logic high = enable; Logic low = shutdown.
2	1	VIN	Input voltage which supplies both the internal circuitry and the current to the output load
3	2	GND	Ground
TAB	TAB	TAB	TAB is connected to ground.
4	3	VOUT	Linear Regulator Output.
5	-	FLG	Error Flag Open collector output. Active-low indicates an output fault condition.

ABSOLUTE MAXIMUM RATINGS

Symbol	Rating	Value	Unit	
V _{IN}	Supply Voltage	0 to 18	V	
V _{EN}	Enable Input Voltage	0 to 18	V	
V _{FLG}	Error Flag Open Collector Output Maximum Voltage	0 to 18	V	
V _{OUT} - V _{IN}	Reverse V _{OUT} - V _{IN} Voltage (EN = Shutdown or V _{IN} = 0 V) (Note 1)	0 to 6.5	V	
P _D	Power Dissipation (Notes 2 and 3)	Internally Limited		
T _J	Junction Temperature	-40 ≤ T _J ≤ +125	°C	
T _S	Storage Temperature	-65 ≤ T _J ≤ +150	°C	
	ESD Rating (Notes 4 and 5)	Human Body Model Machine Model	2000 200	V

Stresses exceeding Maximum Ratings may damage the device. Maximum Ratings are stress ratings only. Functional operation above the Recommended Operating Conditions is not implied. Extended exposure to stresses above the Recommended Operating Conditions may affect device reliability.

NOTE: All voltages are referenced to GND pin unless otherwise noted.

- The ENABLE pin input voltage must be ≤ 0.8 V or V_{IN} must be connected to ground potential.
- $P_{D(max)} = (T_{J(max)} - T_A) / R_{\theta JA}$, where $R_{\theta JA}$ depends upon the printed circuit board layout.
- This protection is not guaranteed outside the Recommended Operating Conditions.
- Devices are ESD sensitive. Handling precautions recommended.
- This device series incorporates ESD protection and is tested by the following methods:
ESD Human Body Model (HBM) tested per AEC-Q100-002 (EIA/JESD22-A114C)
ESD Machine Model (MM) tested per AEC-Q100-003 (EIA/JESD22-A115C)
This device contains latch-up protection and exceeds 100 mA per JEDEC Standard JESD78.

NCP59300, NCV59300 Series

RECOMMENDED OPERATING CONDITIONS (Note 6)

Symbol	Rating	Value	Unit
V _{IN}	Supply Voltage	2.24 to 13.5	V
V _{EN}	Enable Input Voltage	0 to 13.5	V
V _{FLG}	Error Flag Open Collector Voltage	0 to 13.5	V
T _J	Junction Temperature	-40 ≤ T _J ≤ +125	°C

6. The device is not guaranteed to function outside its Recommended operating conditions.

ELECTRICAL CHARACTERISTICS

(T_J = 25°C with V_{IN} = V_{OUT nominal} + 1 V; V_{EN} = V_{IN}; I_L = 10 mA; bold values indicate -40°C < T_J < +125°C, unless noted.)

Parameter	Conditions	Min	Typ	Max	Unit
Output Voltage Accuracy	I _L = 10 mA	-1.5		+1.5	%
	10 mA < I _{OUT} < 3 A, V _{OUT nominal} + 1 ≤ V _{IN} ≤ 13.5 V	-2.5		+2.5	%
Output Voltage Line Regulation	V _{IN} = V _{OUT nominal} + 1.0 V to 13.5 V; I _L = 10 mA		0.02	0.5	%
Output Voltage Load Regulation	I _L = 10 mA to 3 A		0.2	1	%
V _{IN} - V _{OUT} Dropout Voltage (Note 7)	I _L = 1.5 A		175	350	mV
	I _L = 3 A		300	500	mV
Ground Pin Current (Note 8)	I _L = 3 A		60	90 120	mA
Ground Pin Current in Shutdown	V _{EN} ≤ 0.5 V		1.0	5	μA
Overload Protection Current Limit	V _{OUT} = 0 V		3.5	5	A
Output Voltage Start-up Slope	V _{EN} = V _{IN} , I _{OUT} = 10 mA, C _{OUT} = 47 μF (Note 9)		40	200	μs/V

ENABLE INPUT

Enable Input Signal Levels	Regulator enable	1.8			V
	Regulator shutdown			0.8	V
Enable pin Input Current	V _{EN} ≤ 0.8 V (Regulator shutdown)			2 4	μA
	6.5 V > V _{EN} ≥ 1.8 V (Regulator enable)	1	15	30 40	μA

FLAG OUTPUT

I _{flg(leak)}	V _{oh} = 6 V			1 2	μA
V _{FLG(LO)}	V _{IN} = 2.24 V, I _{FLG} = 250 μA		210	400 500	mV
V _{FLG}	Low Threshold, % of V _{OUT}	93	95		%
	Hysteresis		2		%
	High Threshold, % of V _{OUT}		97	99.2	%

7. V_{DO} = V_{IN} - V_{OUT} when V_{OUT} decreases to 98% of its nominal output voltage with V_{IN} = V_{OUT} + 1 V. For output voltages below 1.74 V, dropout voltage specification does not apply due to a minimum input operating voltage of 2.24 V.

8. I_{IN} = I_{GND} + I_{OUT}.

9. Fixed Voltage Device Start-up Time = Output Voltage Start-up Slope x V_{OUT} Nominal.

Package	Conditions / PCB Footprint	Thermal Resistance
D2PAK-3, Junction-to-Case		R _{θJC} = 2.1°C/W
D2PAK-5, Junction-to-Case		R _{θJC} = 2.1°C/W
D2PAK-3, Junction-to-Air	PCB with 100 mm ² 2.0 oz Copper Heat Spreading Area	R _{θJA} = 52°C/W
D2PAK-5, Junction-to-Air	PCB with 100 mm ² 2.0 oz Copper Heat Spreading Area	R _{θJA} = 52°C/W

NCP59300, NCV59300 Series

TYPICAL CHARACTERISTICS

$T_J = 25^\circ\text{C}$ if not otherwise noted

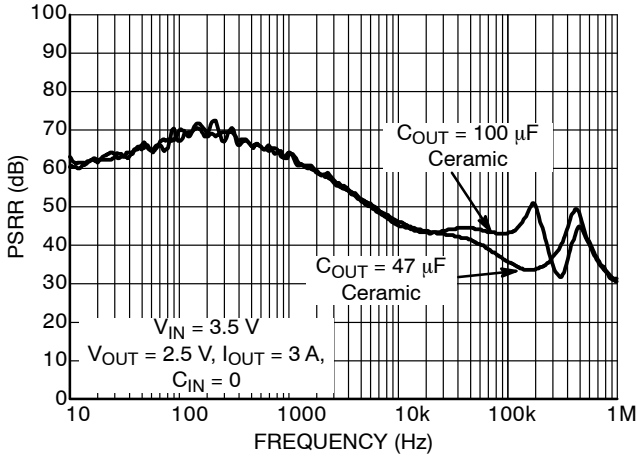

Figure 3. Power Supply Rejection Ratio

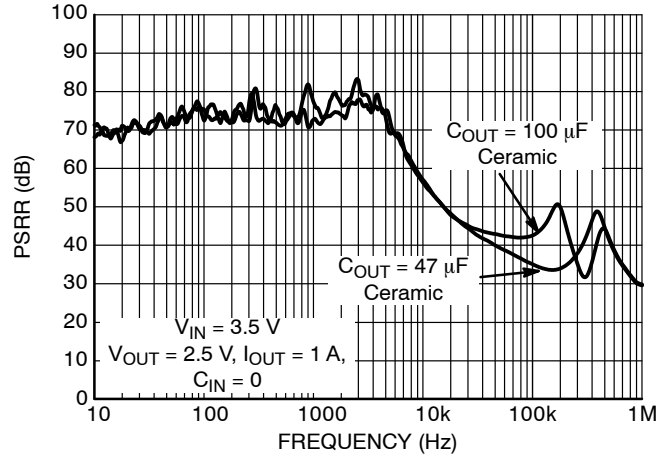

Figure 4. Power Supply Rejection Ratio

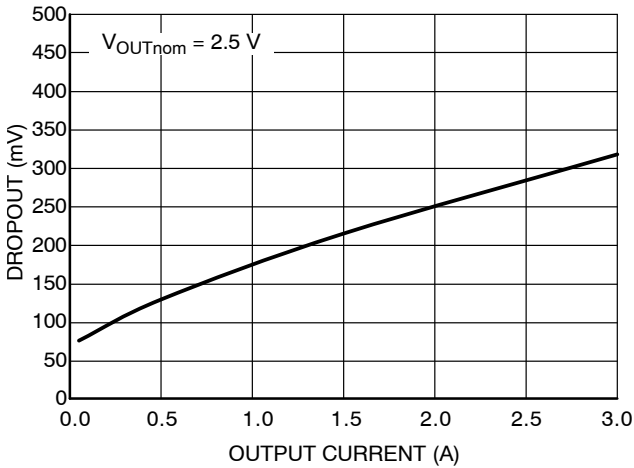

Figure 5. Dropout Voltage vs. Output Current

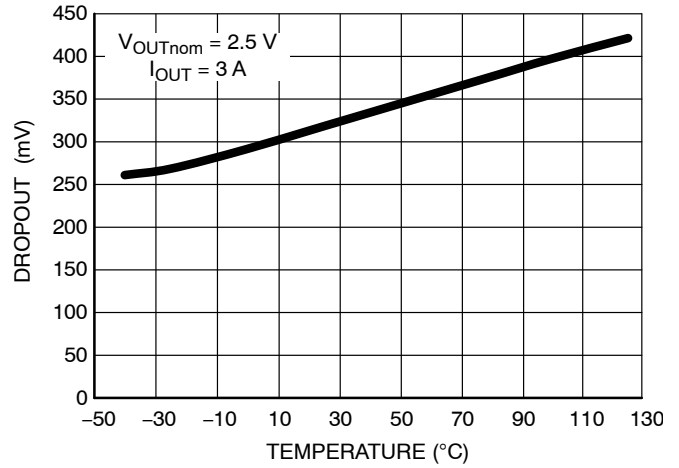

Figure 6. Dropout Voltage vs. Temperature

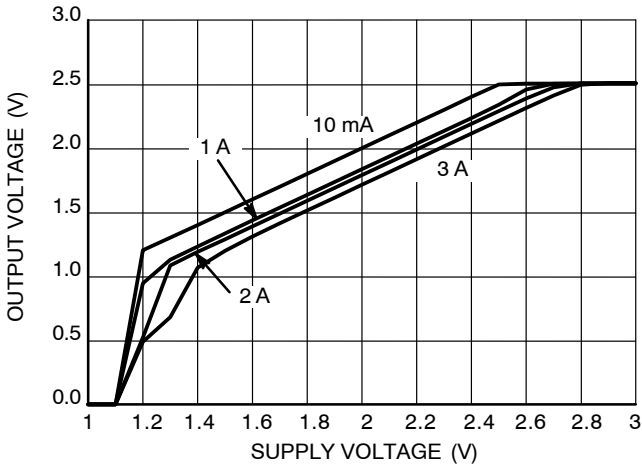

Figure 7. Dropout Characteristics (2.5 V)

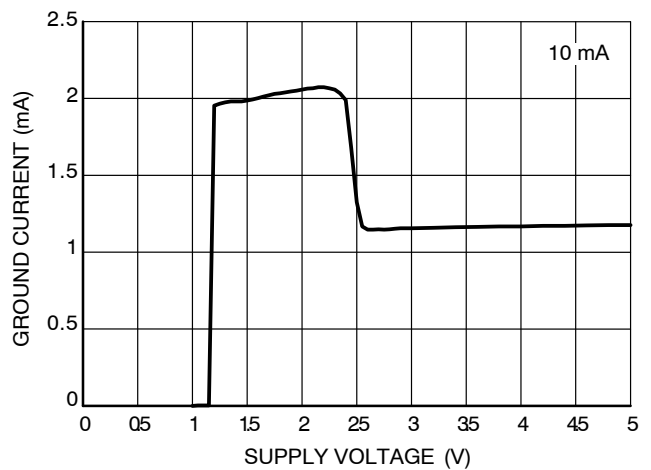

Figure 8. Ground Current vs. Supply Voltage (2.5 V)

NCP59300, NCV59300 Series

TYPICAL CHARACTERISTICS

$T_J = 25^\circ\text{C}$ if not otherwise noted

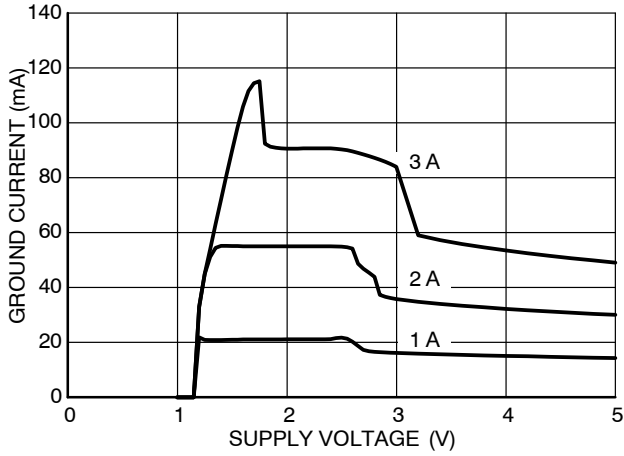

Figure 9. Ground Current vs. Supply Voltage (2.5 V)

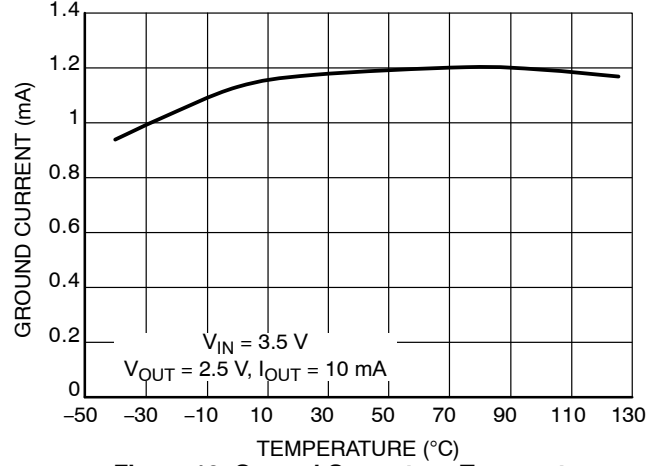

Figure 10. Ground Current vs. Temperature

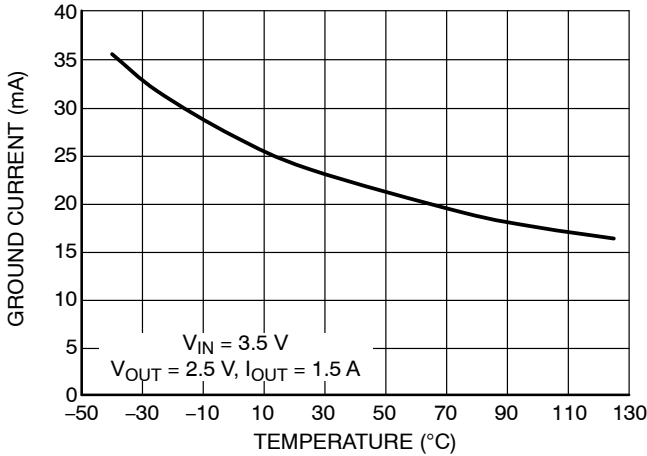

Figure 11. Ground Current vs. Temperature

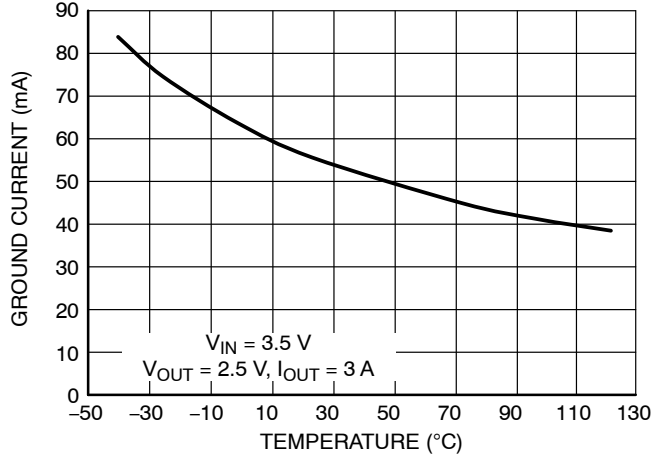

Figure 12. Ground Current vs. Temperature

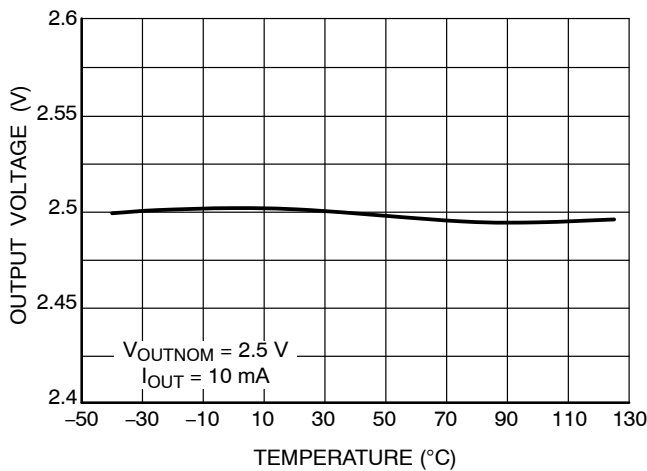

Figure 13. Output Voltage vs. Temperature

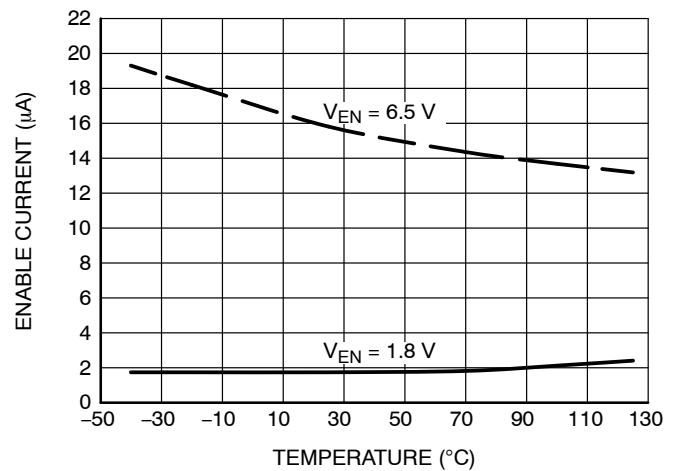

Figure 14. Enable Pin Input Current vs. Temperature

NCP59300, NCV59300 Series

FUNCTIONAL CHARACTERISTICS

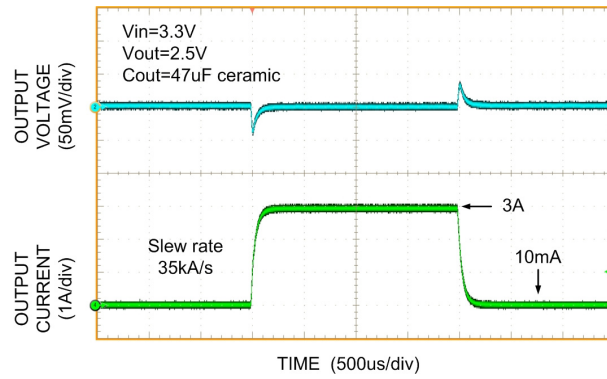

Figure 15. Load Transient Response

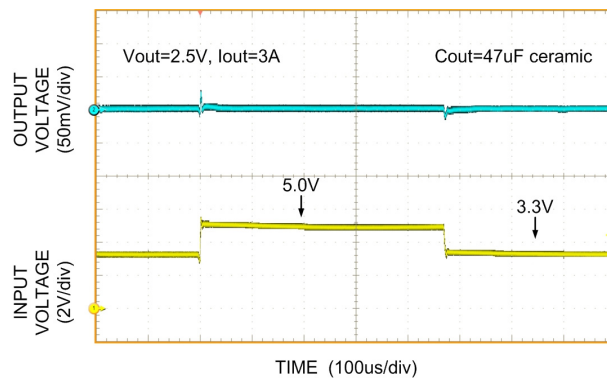

Figure 16. Line Transient Response

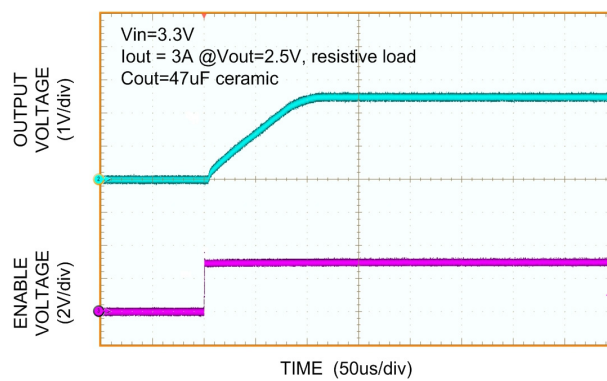

Figure 17. Enable Transient Response

APPLICATIONS INFORMATION

Output Capacitor and Stability

The NCP59300 series requires an output capacitor for stable operation. The NCP59300 series is designed to operate with ceramic output capacitors. The recommended output capacitance value is 47 μF or greater. Such capacitors help to improve transient response and noise reduction at high frequency.

Input Capacitor

An input capacitor of 1.0 μF or greater is recommended when the device is more than 4 inches away from the bulk supply capacitance, or when the supply is a battery. Small, surface-mount chip capacitors can be used for the bypassing. The capacitor should be placed within 1 inch of the device for optimal performance. Larger values will help to improve ripple rejection by bypassing the input of the regulator, further improving the integrity of the output voltage.

Minimum Load Current

The NCP59300 regulator is specified between finite loads. A 10 mA minimum load current is necessary for proper operation.

Error Flag

Some NCP59300 series members feature an error flag circuit that monitors the output voltage and signals an error condition when the voltage is 5% below the nominal output voltage. The error flag is an open-collector output that can sink up to 5 mA typically during a V_{OUT} fault condition.

The FLG output is overload protected when a short circuit of the pullup load resistor occurs in the application. This is guaranteed in the full range of FLG output voltage Max ratings (see Max Ratings table). Please be aware operation in this mode is not recommended, power dissipated in the device can impact on output voltage precision and other device characteristics.

Enable Input

Some NCP59300 series members also feature an enable input for on/off control of the device. Its shutdown state draws “zero” current from input voltage supply (only microamperes of leakage). The enable input is TTL/CMOS compatible for simple logic interface, but can be connected up to V_{IN} .

Overcurrent and Reverse Output Current Protection

The NCP59300 regulator is fully protected from damage due to output current overload conditions. When NCP59300 output is overloaded, Output Current limiting is provided. This limiting is linear; output current during overload conditions is constant. These features are advantageous for powering FPGAs and other ICs having current consumption higher than nominal during their startup.

Thermal shutdown disables the NCP59300 device when the die temperature exceeds the maximum safe operating temperature.

When NCP59300 is disabled and ($V_{\text{OUT}} - V_{\text{IN}}$) voltage difference is less than 6.5 V in the application, the output structure of these regulators is able to withstand output voltage (backup battery as example) to be applied without reverse current flow. Of course the additional current flowing through the Feedback resistor divider inside the NCP59300 Fixed voltage devices (30 μA typically at nominal output voltage) needs to be included in the backup battery discharging calculations.

Thermal Considerations

The power handling capability of the device is limited by the maximum rated junction temperature (125°C). The P_{D} total power dissipated by the device has two components, Input to output voltage differential multiplied by Output current and Input voltage multiplied by GND pin current.

$$P_{\text{D}} = (V_{\text{IN}} - V_{\text{OUT}}) \cdot I_{\text{OUT}} + V_{\text{IN}} \cdot I_{\text{GND}} \quad (\text{eq. 1})$$

The GND pin current value can be found in Electrical Characteristics table and in Typical Characteristics graphs.

The Junction temperature T_{J} is

$$T_{\text{J}} = T_{\text{A}} + P_{\text{D}} \cdot R_{\theta\text{JA}} \quad (\text{eq. 2})$$

where T_{A} is ambient temperature and $R_{\theta\text{JA}}$ is the Junction to Ambient Thermal Resistance of the NCP/NCV59300 device mounted on the specific PCB.

To maximize efficiency of the application and minimize thermal power dissipation of the device it is convenient to use the Input to output voltage differential as low as possible.

The static typical dropout characteristics for various output voltage and output current can be found in the Typical Characteristics graphs.

NCP59300, NCV59300 Series

ORDERING INFORMATION

Device	Output Current	Output Voltage	Junction Temp. Range	Package	Shipping [†]
NCP59300DS18R4G	3.0 A	1.8 V	-40°C to +125°C	D2PAK-3 (Pb-Free)	Under Development Contact Sales Office
NCP59300DS25R4G	3.0 A	2.5 V	-40°C to +125°C	D2PAK-3 (Pb-Free)	Under Development Contact Sales Office
NCP59300DS28R4G	3.0 A	2.8 V	-40°C to +125°C	D2PAK-3 (Pb-Free)	Under Development Contact Sales Office
NCP59300DS30R4G	3.0 A	3.0 V	-40°C to +125°C	D2PAK-3 (Pb-Free)	Under Development Contact Sales Office
NCP59300DS33R4G	3.0 A	3.3 V	-40°C to +125°C	D2PAK-3 (Pb-Free)	Under Development Contact Sales Office
NCP59300DS50R4G	3.0 A	5.0 V	-40°C to +125°C	D2PAK-3 (Pb-Free)	Under Development Contact Sales Office
NCV59300DS18R4G*	3.0 A	1.8 V	-40°C to +125°C	D2PAK-3 (Pb-Free)	Under Development Contact Sales Office
NCV59300DS25R4G*	3.0 A	2.5 V	-40°C to +125°C	D2PAK-3 (Pb-Free)	Under Development Contact Sales Office
NCV59300DS28R4G*	3.0 A	2.8 V	-40°C to +125°C	D2PAK-3 (Pb-Free)	Under Development Contact Sales Office
NCV59300DS30R4G*	3.0 A	3.0 V	-40°C to +125°C	D2PAK-3 (Pb-Free)	Under Development Contact Sales Office
NCV59300DS33R4G*	3.0 A	3.3 V	-40°C to +125°C	D2PAK-3 (Pb-Free)	Under Development Contact Sales Office
NCV59300DS50R4G*	3.0 A	5.0 V	-40°C to +125°C	D2PAK-3 (Pb-Free)	Under Development Contact Sales Office
NCP59301DS18R4G	3.0 A	1.8 V	-40°C to +125°C	D2PAK-5 (Pb-Free)	800 / Tape & Reel
NCP59301DS25R4G	3.0 A	2.5 V	-40°C to +125°C	D2PAK-5 (Pb-Free)	800 / Tape & Reel
NCP59301DS28R4G	3.0 A	2.8 V	-40°C to +125°C	D2PAK-5 (Pb-Free)	800 / Tape & Reel
NCP59301DS30R4G	3.0 A	3.0 V	-40°C to +125°C	D2PAK-5 (Pb-Free)	800 / Tape & Reel
NCP59301DS33R4G	3.0 A	3.3 V	-40°C to +125°C	D2PAK-5 (Pb-Free)	800 / Tape & Reel
NCP59301DS50R4G	3.0 A	5.0 V	-40°C to +125°C	D2PAK-5 (Pb-Free)	800 / Tape & Reel
NCV59301DS18R4G*	3.0 A	1.8 V	-40°C to +125°C	D2PAK-5 (Pb-Free)	800 / Tape & Reel
NCV59301DS25R4G*	3.0 A	2.5 V	-40°C to +125°C	D2PAK-5 (Pb-Free)	800 / Tape & Reel
NCV59301DS28R4G*	3.0 A	2.8 V	-40°C to +125°C	D2PAK-5 (Pb-Free)	800 / Tape & Reel
NCV59301DS30R4G*	3.0 A	3.0 V	-40°C to +125°C	D2PAK-5 (Pb-Free)	800 / Tape & Reel
NCV59301DS33R4G*	3.0 A	3.3 V	-40°C to +125°C	D2PAK-5 (Pb-Free)	800 / Tape & Reel
NCV59301DS50R4G*	3.0 A	5.0 V	-40°C to +125°C	D2PAK-5 (Pb-Free)	800 / Tape & Reel

[†]For information on tape and reel specifications, including part orientation and tape sizes, please refer to our Tape and Reel Packaging Specifications Brochure, BRD8011/D.

*NCV Prefix for Automotive and Other Applications Requiring Unique Site and Control Change Requirements; AEC-Q100 Qualified and PPAP Capable.

NCP59300, NCV59300 Series

PACKAGE DIMENSIONS

D²PAK
CASE 936-03
ISSUE D

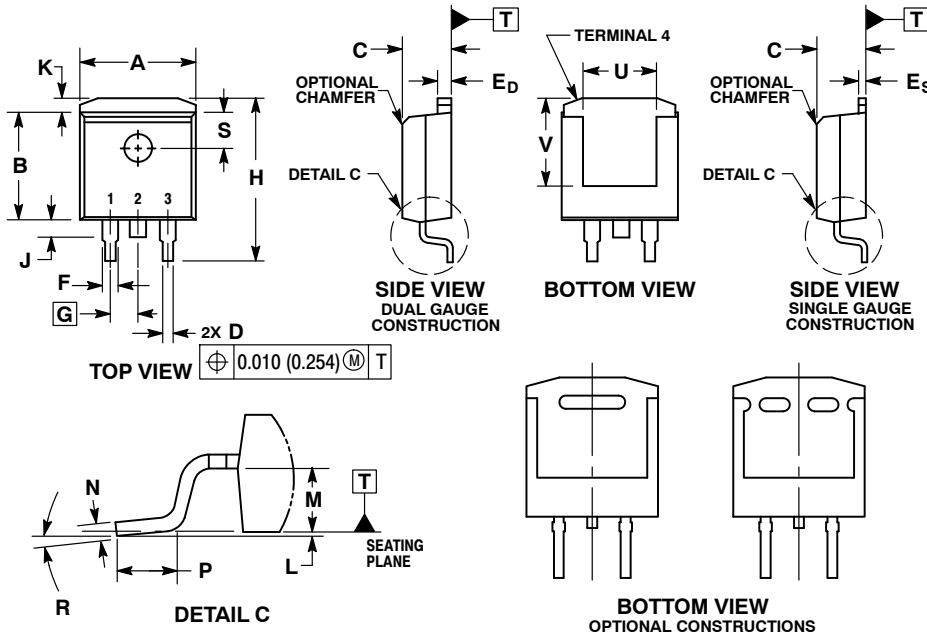

NOTES:

1. DIMENSIONING AND TOLERANCING PER ANSI Y14.5M, 1982.
2. CONTROLLING DIMENSION: INCHES.
3. TAB CONTOUR OPTIONAL WITHIN DIMENSIONS A AND K.
4. DIMENSIONS U AND V ESTABLISH A MINIMUM MOUNTING SURFACE FOR TERMINAL 4.
5. DIMENSIONS A AND B DO NOT INCLUDE MOLD FLASH OR GATE PROTRUSIONS. MOLD FLASH AND GATE PROTRUSIONS NOT TO EXCEED 0.025 (0.635) MAXIMUM.
6. SINGLE GAUGE DESIGN WILL BE SHIPPED AFTER FPCN EXPIRATION IN OCTOBER 2011.

DIM	INCHES		MILLIMETERS	
	MIN	MAX	MIN	MAX
A	0.386	0.403	9.804	10.236
B	0.356	0.368	9.042	9.347
C	0.170	0.180	4.318	4.572
D	0.026	0.036	0.660	0.914
E _D	0.045	0.055	1.143	1.397
E _S	0.018	0.026	0.457	0.660
F	0.051 REF		1.295 REF	
G	0.100 BSC		2.540 BSC	
H	0.539	0.579	13.691	14.707
J	0.125 MAX		3.175 MAX	
K	0.050 REF		1.270 REF	
L	0.000	0.010	0.000	0.254
M	0.088	0.102	2.235	2.591
N	0.018	0.026	0.457	0.660
P	0.058	0.078	1.473	1.981
R	5° REF		5° REF	
S	0.116 REF		2.946 REF	
U	0.200 MIN		5.080 MIN	
V	0.250 MIN		6.350 MIN	

SOLDERING FOOTPRINT*

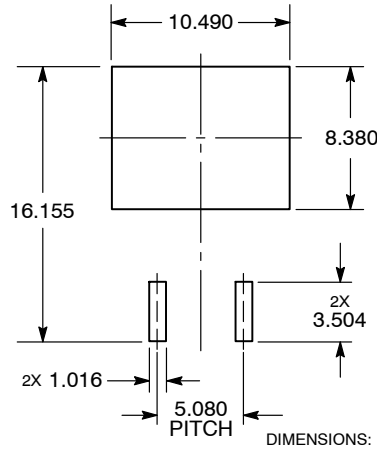

*For additional information on our Pb-Free strategy and soldering details, please download the ON Semiconductor Soldering and Mounting Techniques Reference Manual, SOLDERRM/D.

NCP59300, NCV59300 Series

PACKAGE DIMENSIONS

D²PAK 5 CASE 936A-02 ISSUE C

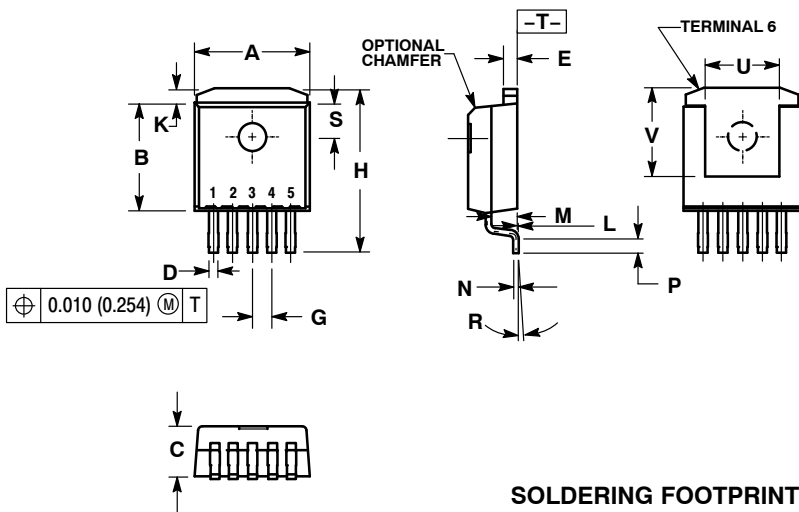

NOTES:

1. DIMENSIONING AND TOLERANCING PER ANSI Y14.5M, 1982.
2. CONTROLLING DIMENSION: INCH.
3. TAB CONTOUR OPTIONAL WITHIN DIMENSIONS A AND K.
4. DIMENSIONS U AND V ESTABLISH A MINIMUM MOUNTING SURFACE FOR TERMINAL 6.
5. DIMENSIONS A AND B DO NOT INCLUDE MOLD FLASH OR GATE PROTRUSIONS. MOLD FLASH AND GATE PROTRUSIONS NOT TO EXCEED 0.025 (0.635) MAXIMUM.

DIM	INCHES		MILLIMETERS	
	MIN	MAX	MIN	MAX
A	0.386	0.403	9.804	10.236
B	0.356	0.368	9.042	9.347
C	0.170	0.180	4.318	4.572
D	0.026	0.036	0.660	0.914
E	0.045	0.055	1.143	1.397
G	0.067 BSC		1.702 BSC	
H	0.539	0.579	13.691	14.707
K	0.050 REF		1.270 REF	
L	0.000	0.010	0.000	0.254
M	0.088	0.102	2.235	2.591
N	0.018	0.026	0.457	0.660
P	0.058	0.078	1.473	1.981
R	5° REF		5° REF	
S	0.116 REF		2.946 REF	
U	0.200 MIN		5.080 MIN	
V	0.250 MIN		6.350 MIN	

SOLDERING FOOTPRINT

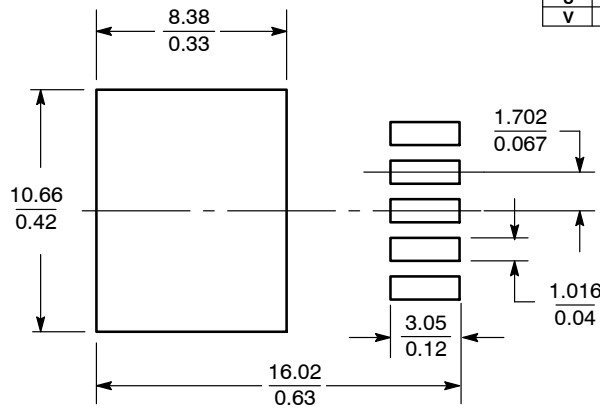

SCALE 3:1 ($\frac{\text{mm}}{\text{inches}}$)

5-LEAD D²PAK

ON Semiconductor and **ON** are registered trademarks of Semiconductor Components Industries, LLC (SCILLC). SCILLC owns the rights to a number of patents, trademarks, copyrights, trade secrets, and other intellectual property. A listing of SCILLC's product/patent coverage may be accessed at www.onsemi.com/site/pdf/Patent-Marking.pdf. SCILLC reserves the right to make changes without further notice to any products herein. SCILLC makes no warranty, representation or guarantee regarding the suitability of its products for any particular purpose, nor does SCILLC assume any liability arising out of the application or use of any product or circuit, and specifically disclaims any and all liability, including without limitation special, consequential or incidental damages. "Typical" parameters which may be provided in SCILLC data sheets and/or specifications can and do vary in different applications and actual performance may vary over time. All operating parameters, including "Typicals" must be validated for each customer application by customer's technical experts. SCILLC does not convey any license under its patent rights nor the rights of others. SCILLC products are not designed, intended, or authorized for use as components in systems intended for surgical implant into the body, or other applications intended to support or sustain life, or for any other application in which the failure of the SCILLC product could create a situation where personal injury or death may occur. Should Buyer purchase or use SCILLC products for any such unintended or unauthorized application, Buyer shall indemnify and hold SCILLC and its officers, employees, subsidiaries, affiliates, and distributors harmless against all claims, costs, damages, and expenses, and reasonable attorney fees arising out of, directly or indirectly, any claim of personal injury or death associated with such unintended or unauthorized use, even if such claim alleges that SCILLC was negligent regarding the design or manufacture of the part. SCILLC is an Equal Opportunity/Affirmative Action Employer. This literature is subject to all applicable copyright laws and is not for resale in any manner.

PUBLICATION ORDERING INFORMATION

LITERATURE FULFILLMENT:

Literature Distribution Center for ON Semiconductor
P.O. Box 5163, Denver, Colorado 80217 USA
Phone: 303-675-2175 or 800-344-3860 Toll Free USA/Canada
Fax: 303-675-2176 or 800-344-3867 Toll Free USA/Canada
Email: orderlit@onsemi.com

N. American Technical Support: 800-282-9855 Toll Free
USA/Canada
Europe, Middle East and Africa Technical Support:
Phone: 421 33 790 2910
Japan Customer Focus Center
Phone: 81-3-5817-1050

ON Semiconductor Website: www.onsemi.com

Order Literature: <http://www.onsemi.com/orderlit>

For additional information, please contact your local Sales Representative