



PART No. 1418N4S16P8

for more information visit
www.hammfg.com

Data subject to change without notice

Isometric drawing Not to Scale

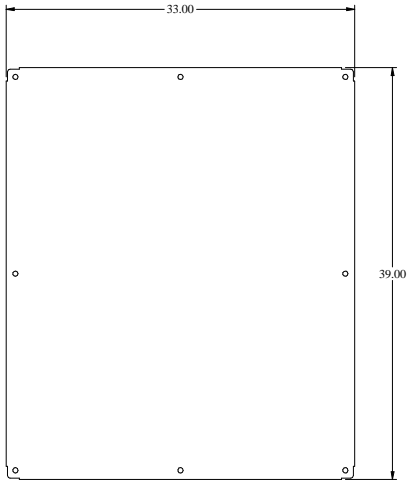

INNER PANEL

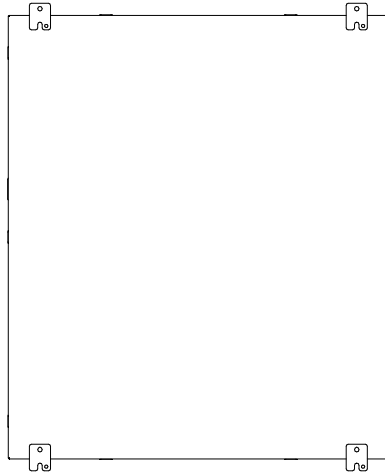

BACK VIEW

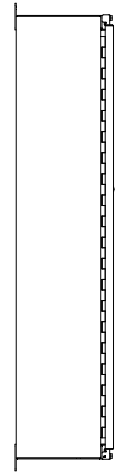

SIDE VIEW

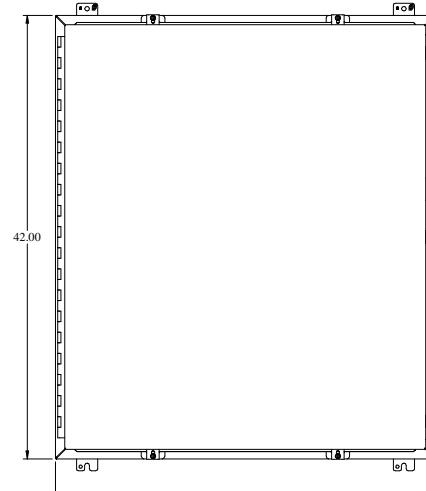

FRONT VIEW



BOTTOM VIEW

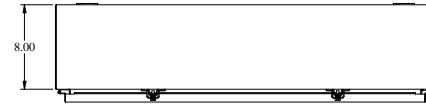

TOP VIEW

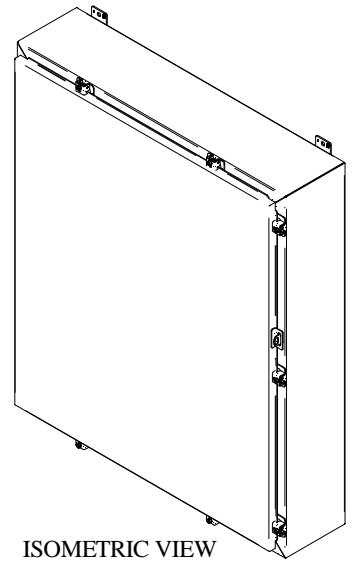

ISOMETRIC VIEW

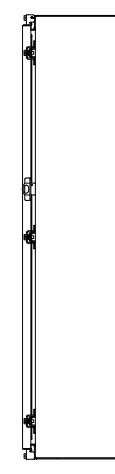

SIDE VIEW