

# SmartGLCD

240x128

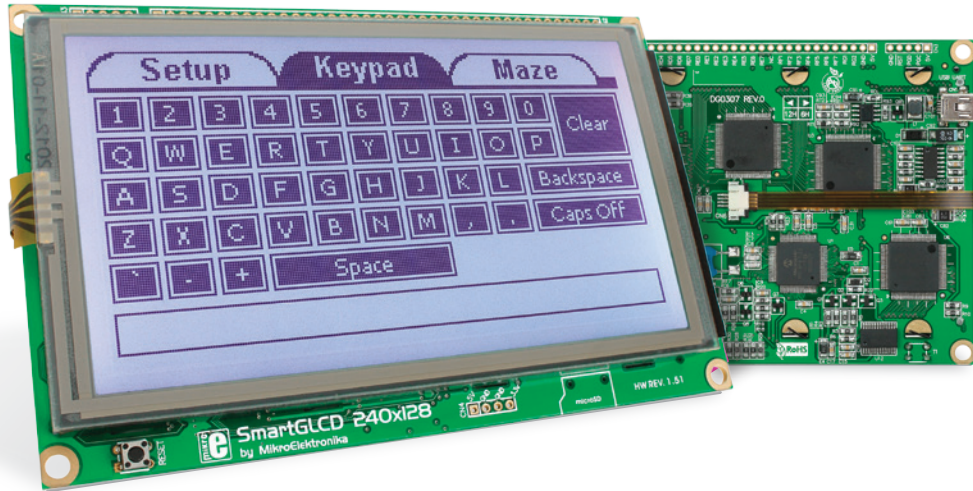

# TO OUR VALUED CUSTOMERS

I want to express my thanks to you for being interested in our products and for having confidence in MikroElektronika.

The primary aim of our company is to design and produce high quality electronic products and to constantly improve the performance thereof in order to better suit your needs.

A handwritten signature in white ink, appearing to read 'N. Matic', is positioned on the right side of the page. The signature is fluid and cursive, with a large initial 'N' and 'M'.

Nebojsa Matic  
General Manager

# Table of Contents

What is the SmartGLCD 240x128?	4	step 5 - Uploading .hex file	15
Package Contains	5	step 6 - Progress bar	16
1. Key Features	6	step 7 - Finishing upload	16
System Specification	7	Tips and Tricks: Speed-up UART data transfer	17
2. Power supply	8	6. Programming with mikroProg™ programmer	18
3. PIC18F87K22 microcontroller	10	7. mikroProg Suite™ for PIC® Software	20
Key microcontroller features	10	8. microSD Card Slot	22
4. Programming the microcontroller	11	9. Touch Screen	24
5. Programming with bootloader	12	10. RGB backlight	26
mikroBootloader software	12	11. Contrast potentiometer	27
Identifying device COM port	13	12. USB UART	28
step 1 - Choosing COM port	13	13. Buzzer	30
step 2 - Establishing Connection	14	14. Pinout	32
step 3 - Browsing for .HEX file	14	15. Dimensions	33
step 4 - Selecting .hex file	15	What's next?	34

# What is the SmartGLCD 240x128?

The SmartGLCD 240x128 is a compact smart display, with many on-board peripherals. It's designed to become a control interface of your device. Main part of the board is a large 240x128 pixel graphical LCD with a 4-wire resistive touch screen. It features RGB backlight, which can greatly improve user experience, but can also be used as a signaling feature. The heart of the board is PIC18F87K22, an 8-bit microcontroller delivering 12MIPS of processing power. Other modules like USB UART, piezo buzzer, microSD slot and connection pads can be found on board as well. The board is preprogrammed with UART bootloader. We have also provided a nice example which will give you a great out-of-the-box experience.

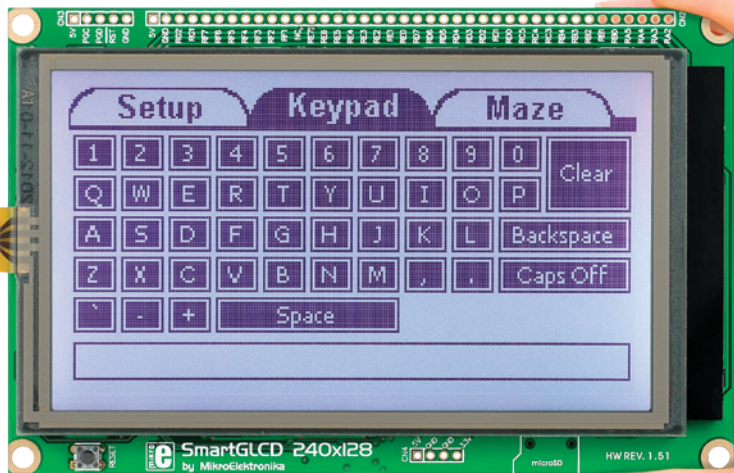

# Package Contains



- 01 Damage resistant protective box



- 02 SmartGLCD 240x128 development board



- 03 DVD with documentation and examples



- 04 SmartGLCD 240x128 user's guide



- 05 SmartGLCD 240x128 schematic and pinout



- 06 USB cable

# 1. Key Features

- 01 GLCD 240x128 display
- 02 RESET button
- 03 Power supply pads
- 04 I/O pads
- 05 Pads for mikroProg programmer
- 06 USB connector
- 07 Touch panel connector
- 08 PIC18F87K22 microcontroller
- 09 Contrast potentiometer
- 10 microSD card slot
- 11 USB UART module
- 12 Buzzer

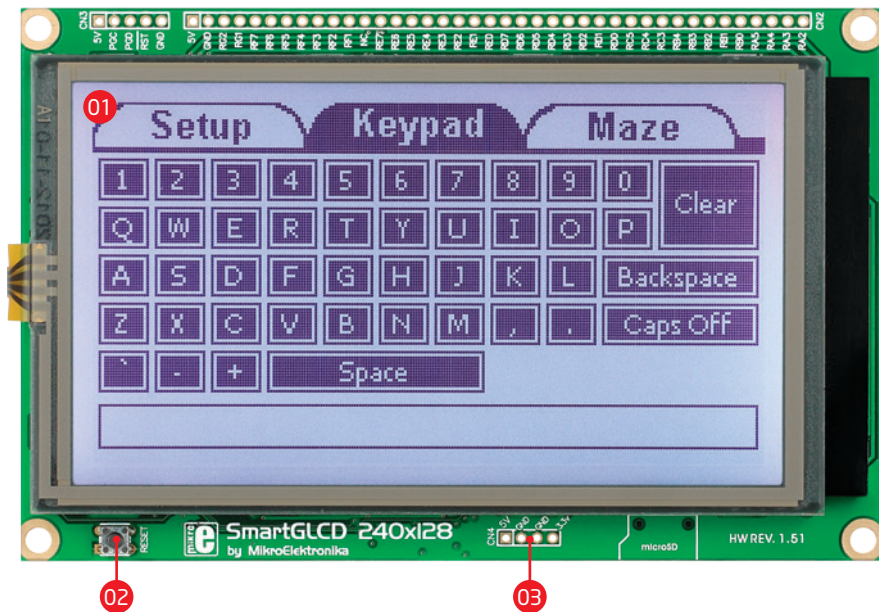

## System Specification

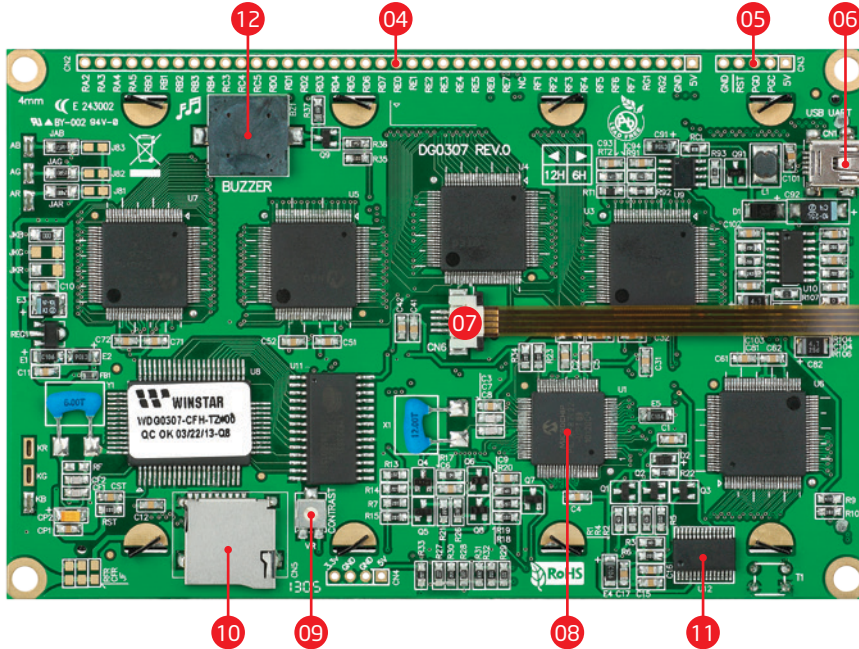

**power supply**  
Via USB cable (5V DC)



**power consumption**  
~350mA in idle state  
(backlight is ON)

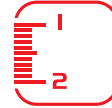

**board dimensions**  
140x90cm (5.51x3.24")



**weight**  
~210g (0.46 lbs)



## 2. Power supply

The SmartGLCD board can be powered in two different ways: via USB connector (**CN1**) using MINI-B USB cable provided with the board (**Figure 2-1**), or via side headers (**CN2** or **CN4**) using external 5V power supply (**Figure 2-2** and **Figure 2-3**).

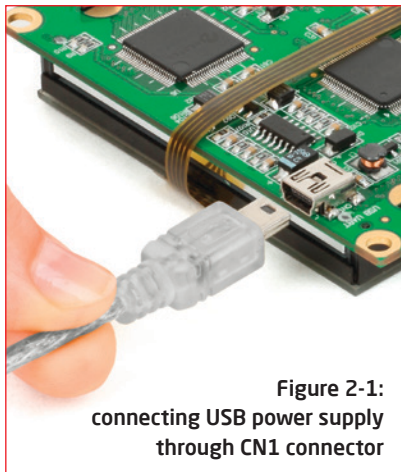

**Figure 2-1:**  
connecting USB power supply  
through CN1 connector

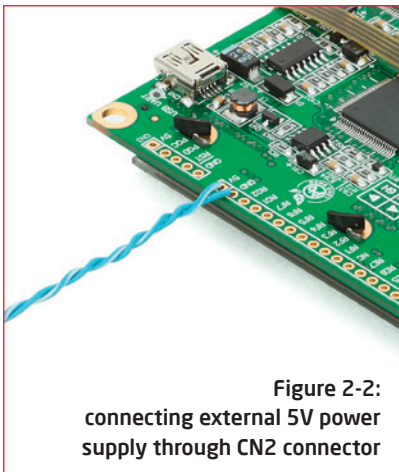

**Figure 2-2:**  
connecting external 5V power  
supply through CN2 connector

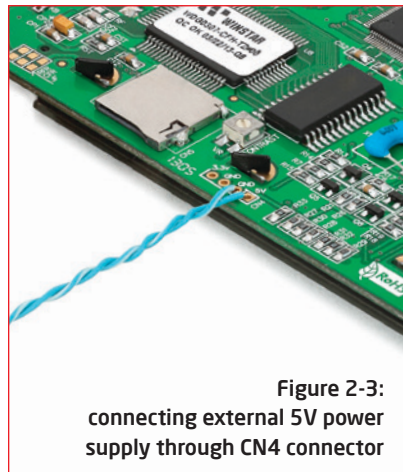

**Figure 2-3:**  
connecting external 5V power  
supply through CN4 connector

When the board is powered up the GLCD display will be automatically turned on. The USB connection can provide up to 500mA of current which is more than enough for the operation of all on-board modules and the microcontroller as well.



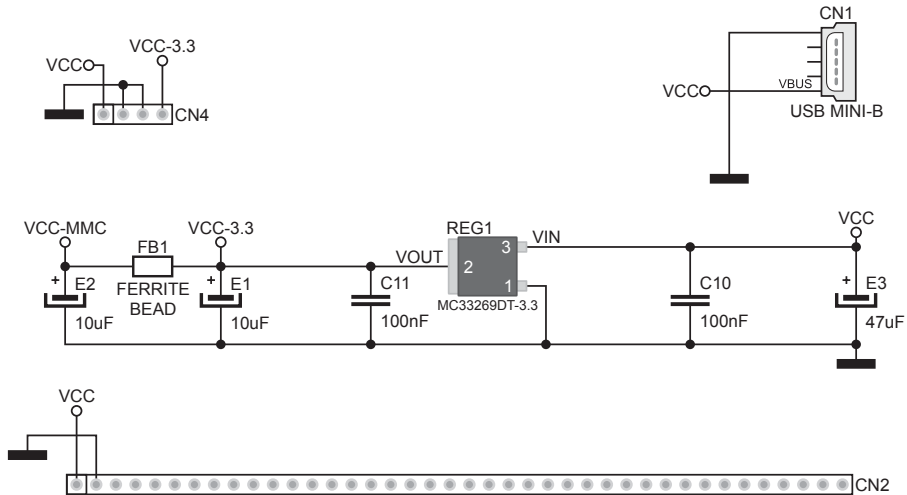

Figure 2-4: Power supply schematic

# 3. PIC18F87K22 microcontroller

The SmartGLCD development tool comes with the **PIC18F87K22** microcontroller. This 8-bit microcontroller is rich with on-chip peripherals and features 128KB of Flash and 4KB of RAM. It can easily handle demanding graphical applications.

## Key microcontroller features

- Up to **12 MIPS** Operation;
- 8-bit architecture;
- 128KB of Flash memory;
- 3,862 bytes of RAM;
- 1024 bytes of EEPROM;
- 80 pin TQFP;
- 24 ch, 12-bit ADC;
- UART, SPI, I<sup>2</sup>C; etc.

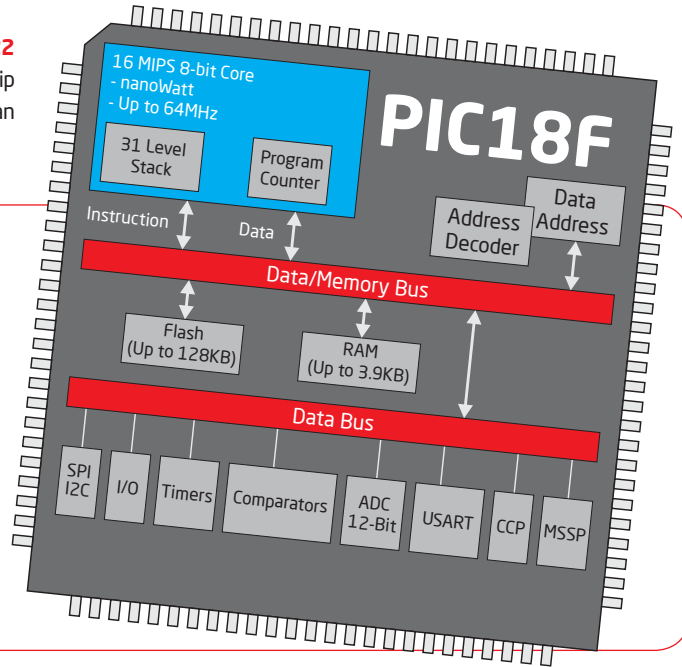

## 4. Programming the microcontroller

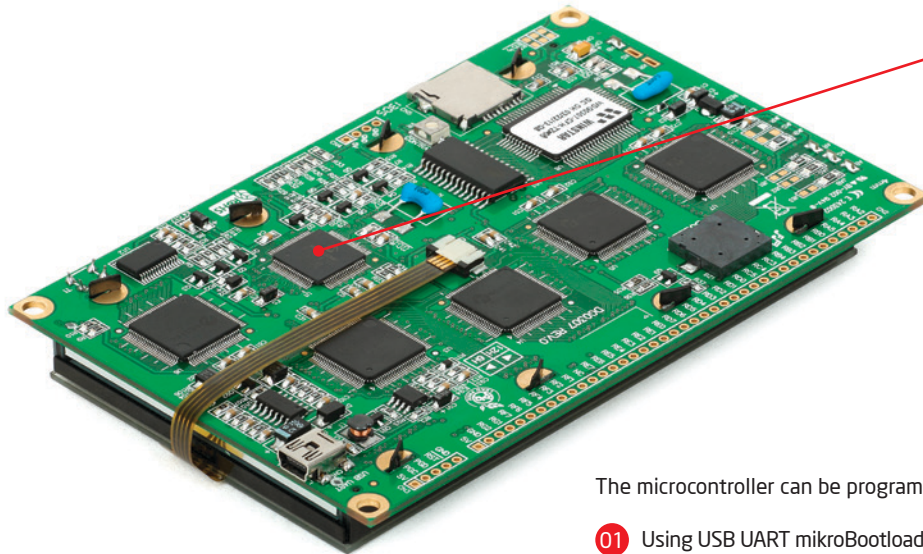

Figure 4-1:  
PIC18F87K22  
microcontroller

The microcontroller can be programmed in two ways:

- 01 Using USB UART mikroBootloader
- 02 Using external mikroProg™ for PIC, dsPIC, PIC32 programmer

# 5. Programming with bootloader

Microcontroller is preprogrammed with USB UART Bootloader, which can be used to upload new device firmware. To transfer firmware .HEX file from a PC to MCU you need to use mikroBootloader USB UART application, which can be downloaded from:

<http://www.mikroe.com/smartglcd/>

Upon download, unzip it to desired location and start the mikroBootloader application:

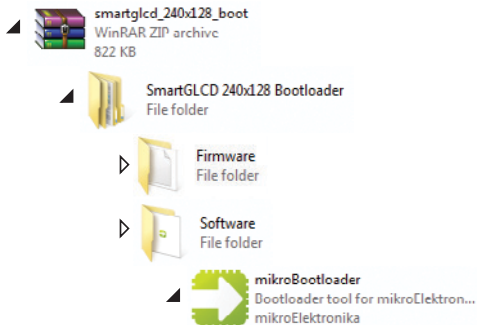

## mikroBootloader software

**note** Before starting mikroBootloader software, connect SmartGLCD to a PC using a USB cable provided with the package.

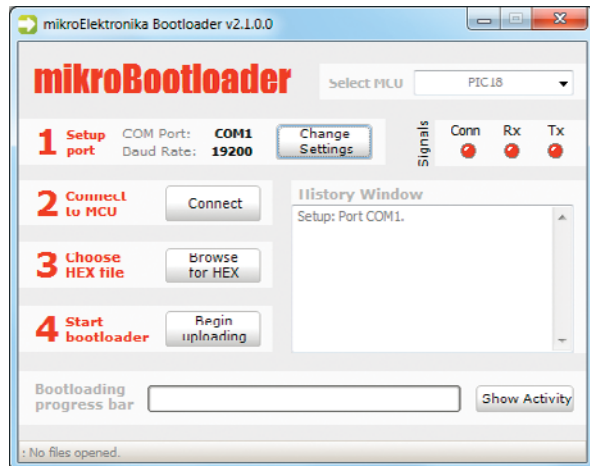

Figure 5-1: mikroBootloader window

**01** When you start mikroBootloader software a window should appear, as shown in the image above.

## Identifying device COM port

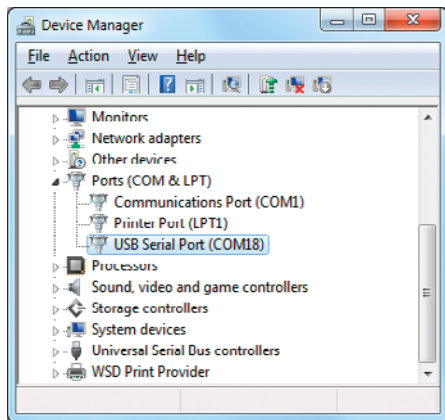

Figure 5-2: Identifying COM port

- 01 Open **Device Manager** window and expand **Ports (COM & LPT)** section to check which COM port is assigned to SmartGLCD board (in this case it is COM18).

## step 1 - Choosing COM port

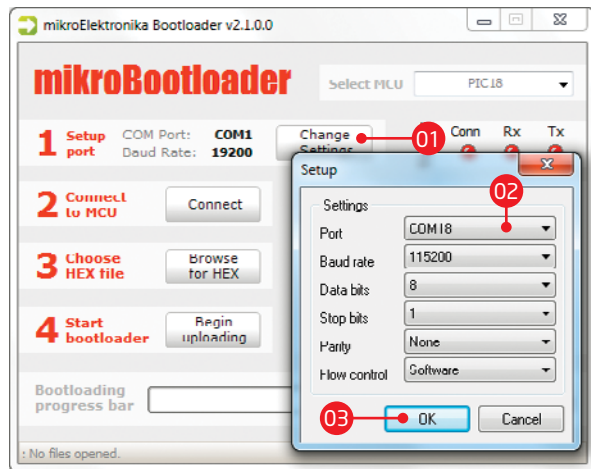

Figure 5-3: Choosing COM port

- 01 Click the **Change Settings** button.
- 02 From the drop down list, select appropriate **Port** (in this case it is COM18) and **Baud rate** (115200).
- 03 Click **OK**.

## step 2 - Establishing Connection



Figure 5-4: Connecting with mikroBootloader

- 01 Press the **Reset** button on SmartGLCD board and **click Connect** within 5s, otherwise the existing microcontroller program will run. If connected, the button's caption will be changed to **Disconnect**.

## step 3 - Browsing for .HEX file

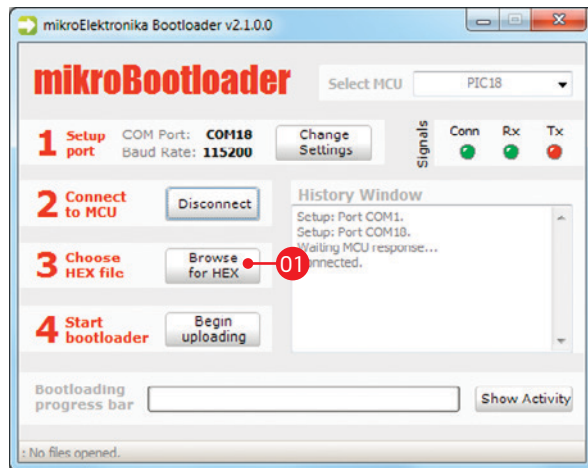

Figure 5-5: Browse for HEX

- 01 Click the **Browse for HEX** button and from a pop-up window (Figure 5-6) choose a .HEX file to be uploaded in MCU memory.

## step 4 - Selecting .hex file

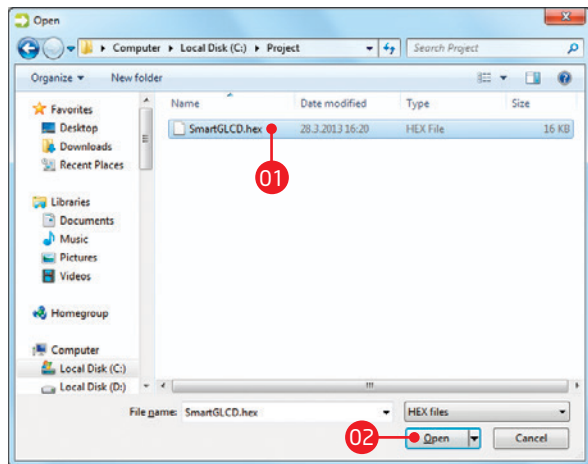

Figure 5-6: Locating and selecting .hex file

- 01 Select .HEX file from the **Open dialog** window.
- 02 Click the **Open** button.

## step 5 - Uploading .hex file

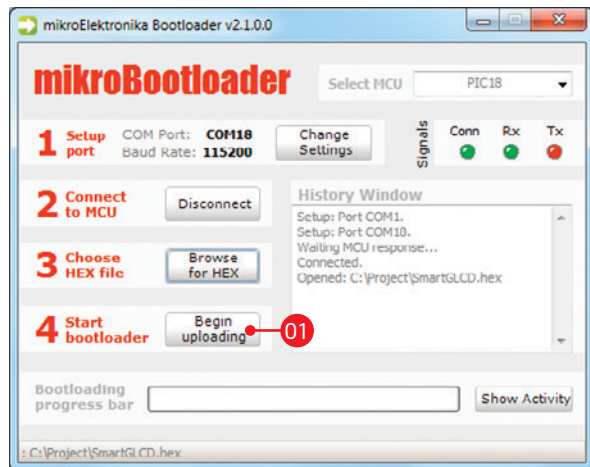

Figure 5-7: Begin uploading

- 01 In order to upload .HEX file click the **Begin uploading** button.



## step 6 - Progress bar



Figure 5-8: Progress bar

- 01 Progress bar enables you to monitor .HEX file uploading.

## step 7 - Finishing upload

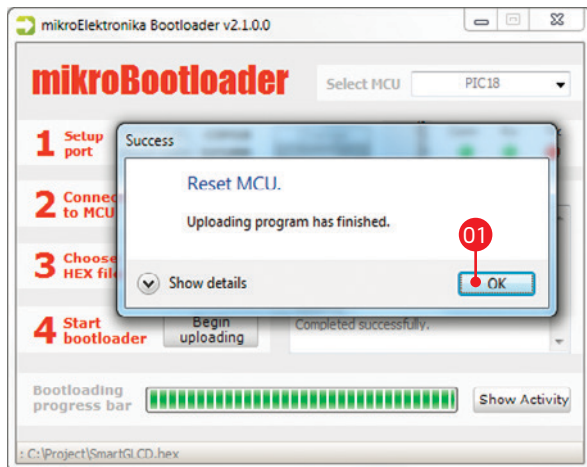
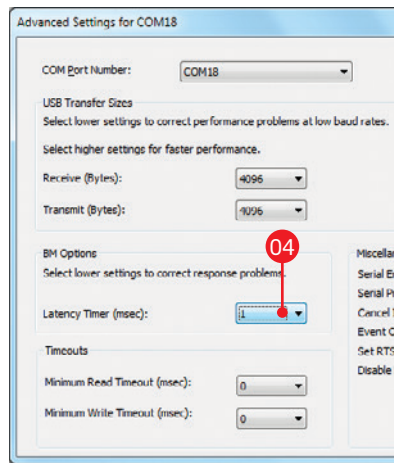
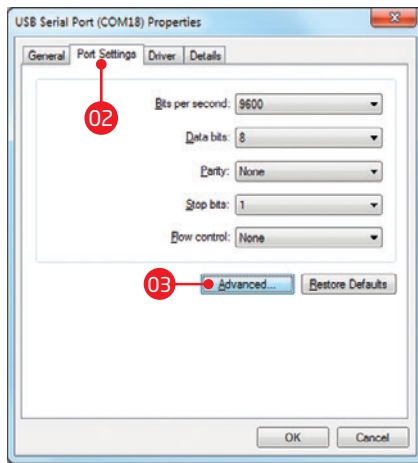
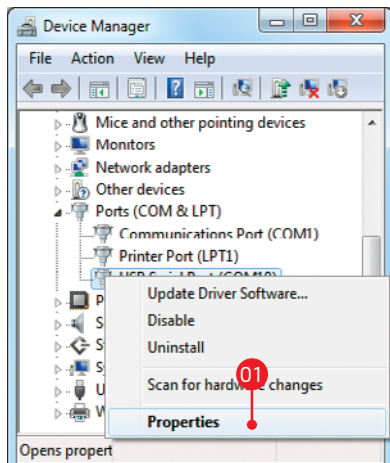

Figure 5-9: Restarting MCU

- 01 Click **OK** button after the uploading process has been finished.
- 02 Press **Reset** button on SmartGLCD board and wait for 5 seconds. Your program will run automatically.

## Tips and Tricks: Speed-up UART data transfer



**note** If .HEX file transfer from your PC to MCU is too slow, it's possible to speed up data transfer by setting latency time of COM port to 1 ms. This is done in Device Manager:

- 01 Right click on the **USB Serial Port (COM18)** item and then select **Properties**.
- 02 Select **Port Settings** tab.
- 03 Click the **Advanced...** button.
- 04 Set **Latency Timer** to **1** and click **OK**.

## 6. Programming with mikroProg™ programmer

The microcontroller can be programmed with the external **mikroProg™** programmer which can be connected to the board via **CN3** connector. Before establishing this connection it is necessary to solder 1x5 male header to **CN3** connection pads. This can be done in both ways: on the bottom, or the top side, as shown in **Figures 6-1** and **6-2**.

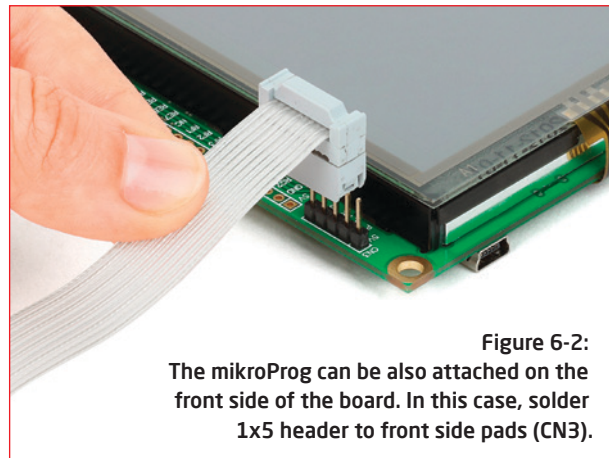
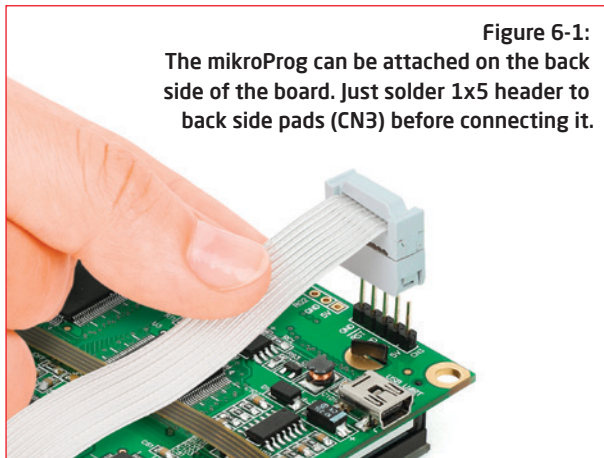

**note** If bootloader program is accidentally erased you can upload it again through mikroProg programmer. Program [Bootloader18F87K22.hex](#) can be found under Firmware folder (page 12).



# 7. mikroProg Suite™ for PIC® Software



The **mikroProg™** programmer requires special programming software called **mikroProg Suite™ for PIC®**. It can be used for programming all Microchip® microcontroller families, including PIC10®, PIC12®, PIC16®, PIC18®, dsPIC30/33®, PIC24® and PIC32®. The software has intuitive interface and SingleClick™ programming technology. Just download the latest version of **mikroProg Suite™** and your programmer is ready to program new devices. **mikroProg Suite™** is updated regularly, at least four times a year, so your programmer will be more and more powerful with each new release.

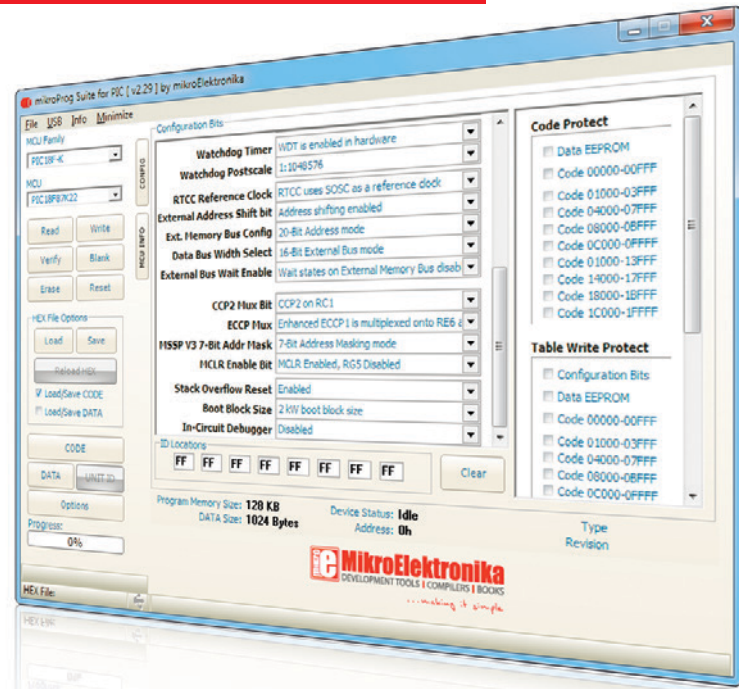
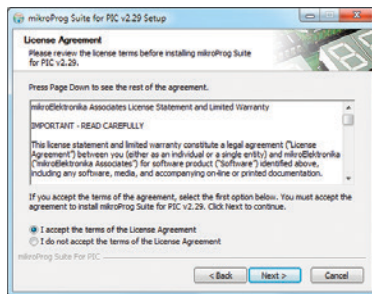

Figure 7-1: Main window of mikroProg Suite™ for PIC® programming software

# Software Installation Wizard



01 Start Installation



02 Accept EULA and continue

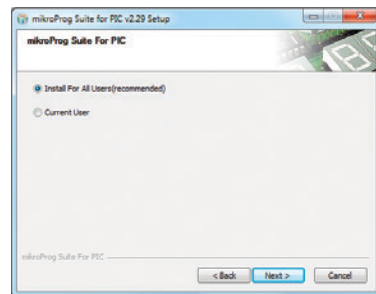

03 Install for all users

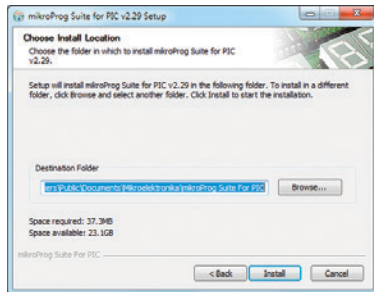

04 Choose destination folder

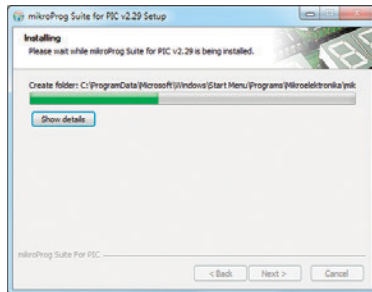

05 Installation in progress



06 Finish installation

## 8. microSD Card Slot

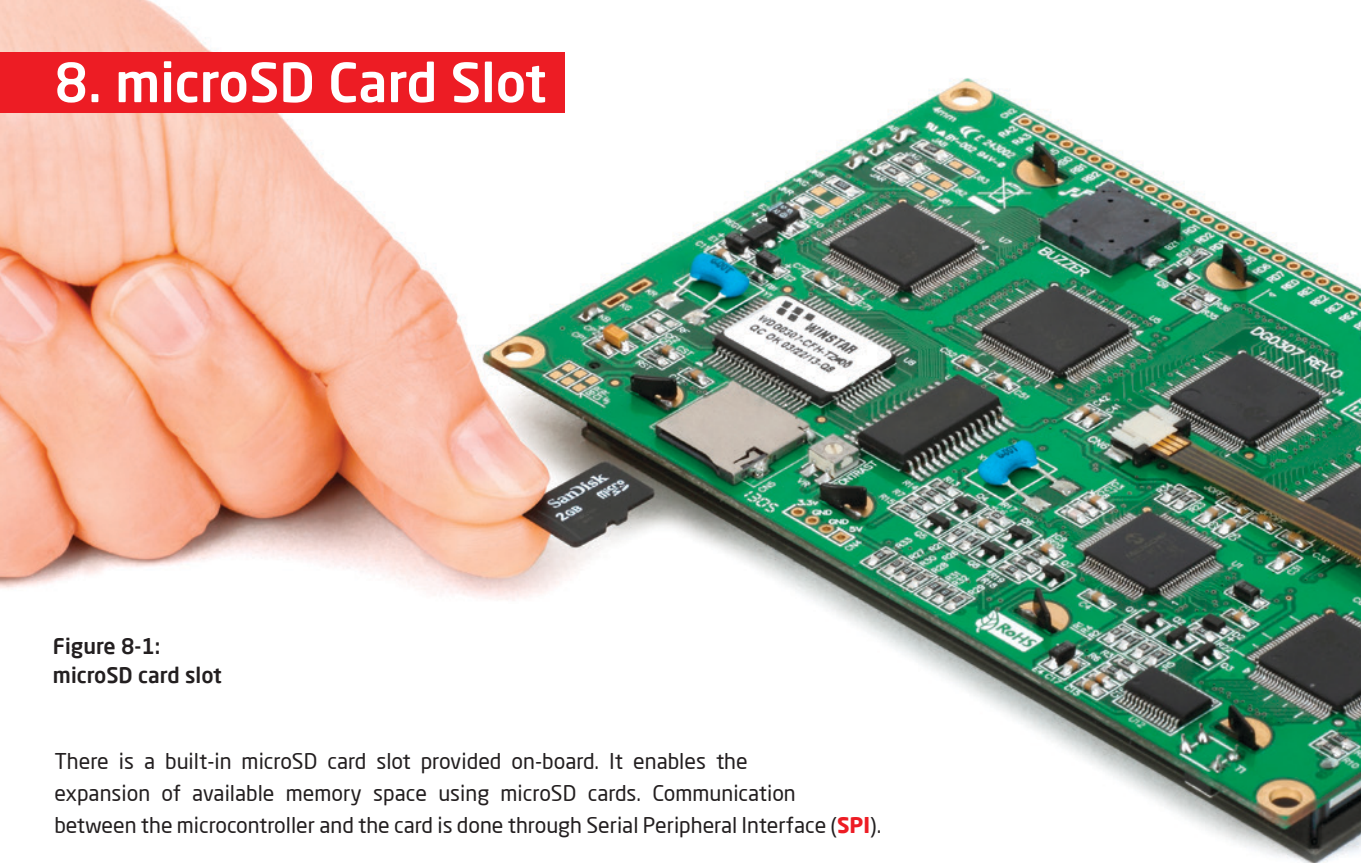

**Figure 8-1:**  
microSD card slot

There is a built-in microSD card slot provided on-board. It enables the expansion of available memory space using microSD cards. Communication between the microcontroller and the card is done through Serial Peripheral Interface (**SPI**).



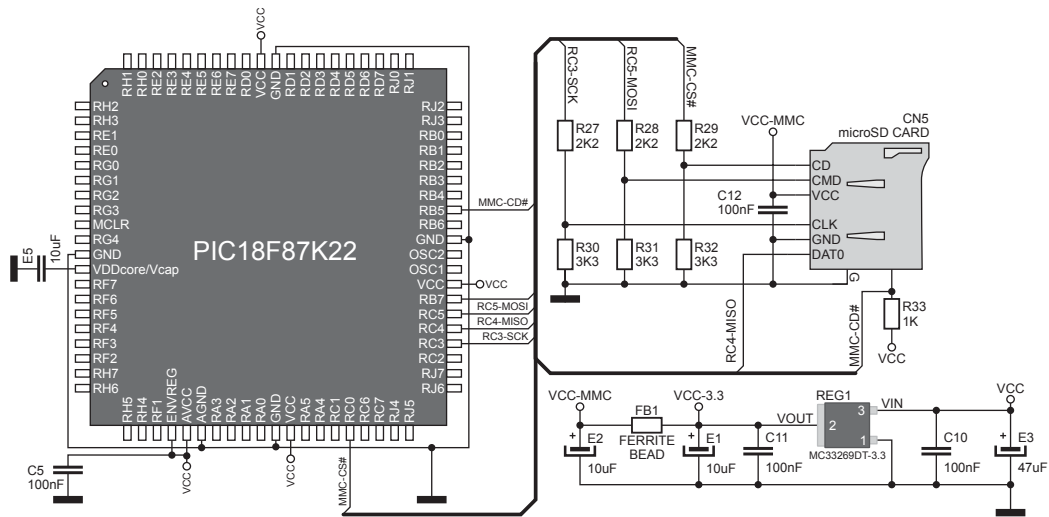
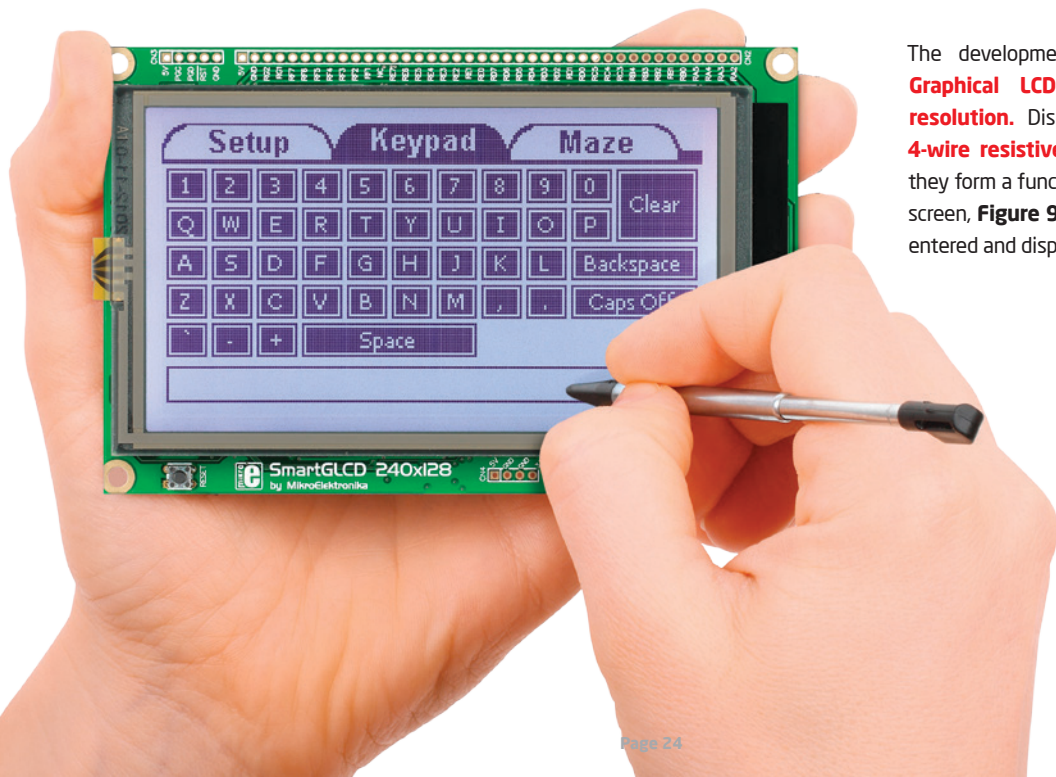

Figure 8-2: microSD Card Slot module connection schematic

## 9. Touch Screen



The development system features a **Graphical LCD in 240x128 pixel resolution**. Display is covered with a **4-wire resistive** touch panel. Together they form a functional unit called a touch screen, **Figure 9-1**. It enables data to be entered and displayed at the same time.

**Figure 9-1:**  
**Touch Screen**



# 10. RGB backlight

Graphical LCDs are only capable of showing monochromatic pixel but not color content. The color of the pixel is determined by the color of the backlight which illuminates the display. SmartGLCD has **the RGB color backlight** - a very useful feature which can give your graphical user interfaces an astonishing look.

Display's backlight module consists of three LEDs: red, green and blue, which can shine simultaneously. LED can be driven by PWM signals coming from three separate microcontroller pins. Duty ratio of the PWM signal determines the intensity of color (or brightness) of each LED. Combined together they can create more than 16 million different backlight colors.

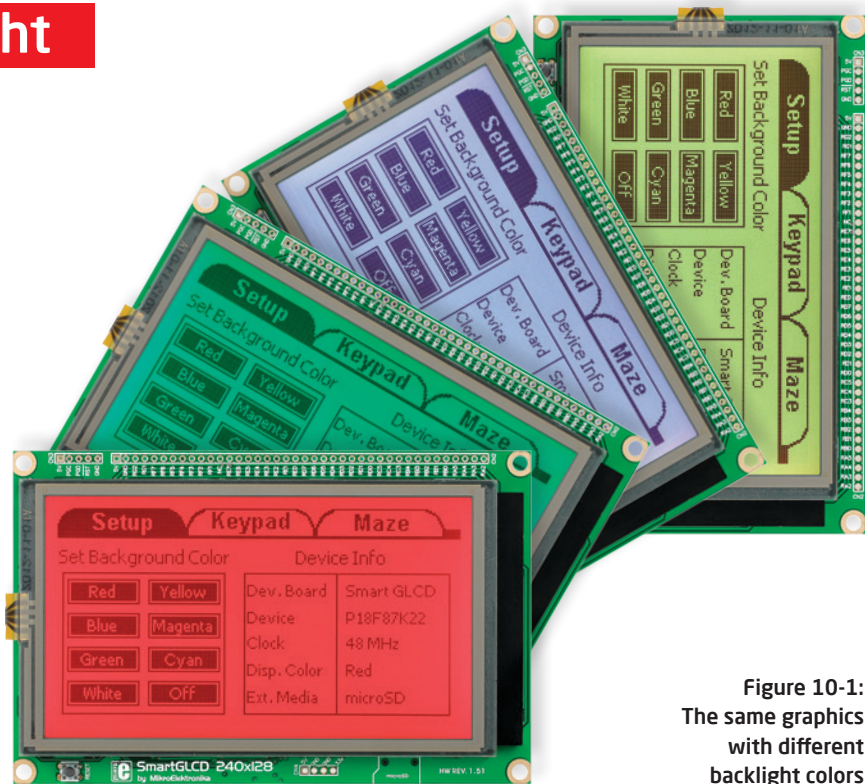
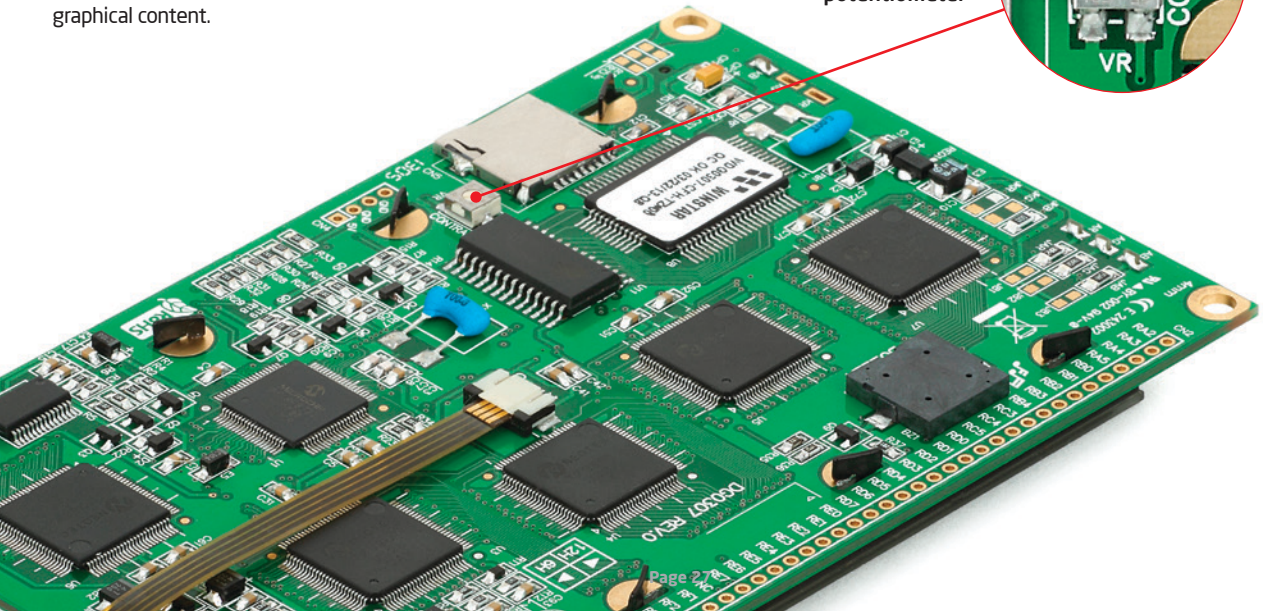

Figure 10-1:  
The same graphics  
with different  
backlight colors

# 11. Contrast potentiometer

On the backside of the board there is a small potentiometer which can be used to change contrast of the GLCD. The brighter the backlight, the less contrast you will need to properly display the graphical content.

Figure 11-1:  
Contrast potentiometer





## 12. USB UART

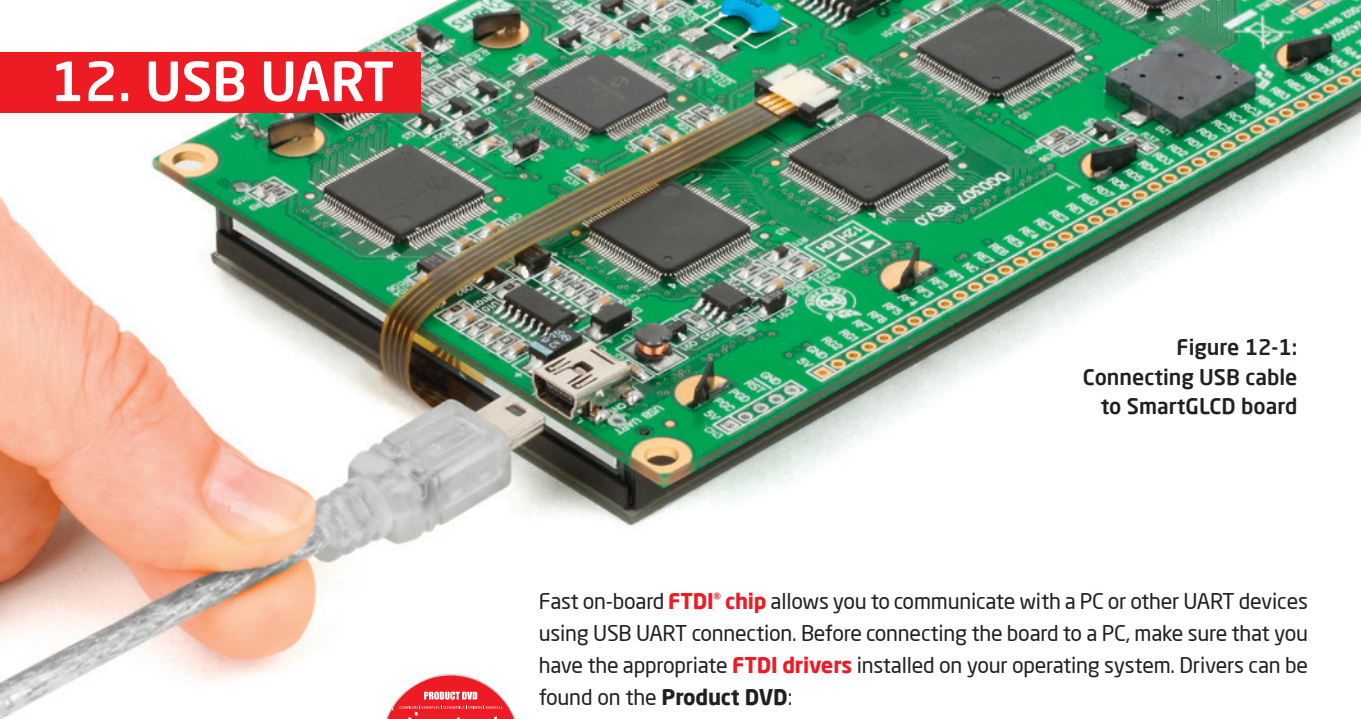

Figure 12-1:  
Connecting USB cable  
to SmartGLCD board

Fast on-board **FTDI® chip** allows you to communicate with a PC or other UART devices using USB UART connection. Before connecting the board to a PC, make sure that you have the appropriate **FTDI drivers** installed on your operating system. Drivers can be found on the **Product DVD**:

[DVD://download/eng/software/development-tools/universal/ftdi/vcp\\_drivers.zip](DVD://download/eng/software/development-tools/universal/ftdi/vcp_drivers.zip)

USB-B connector (**CN1**) is used for connecting the USB cable, which is delivered with the board package. Plug it in as shown in **Figure 12-1**.



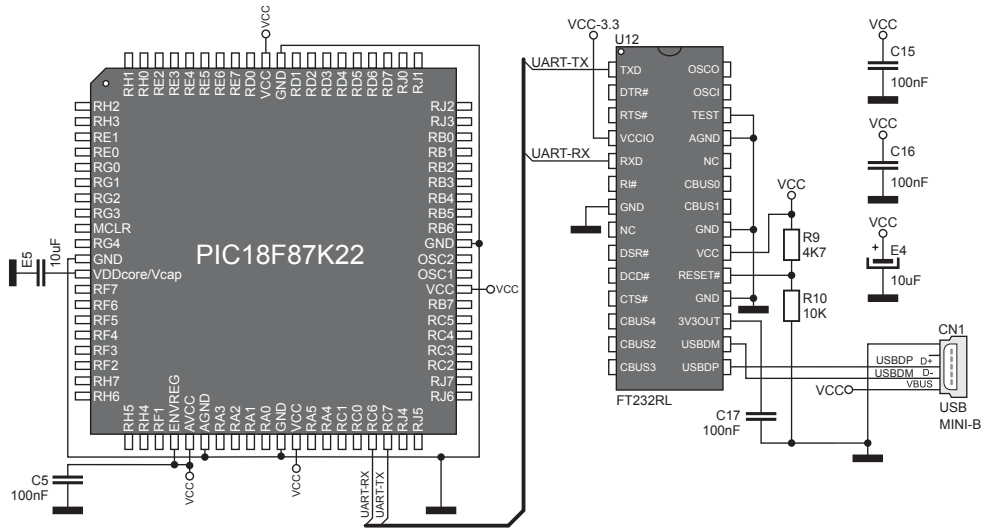

Figure 12-2: USB UART module connection schematic



# 13. Buzzer

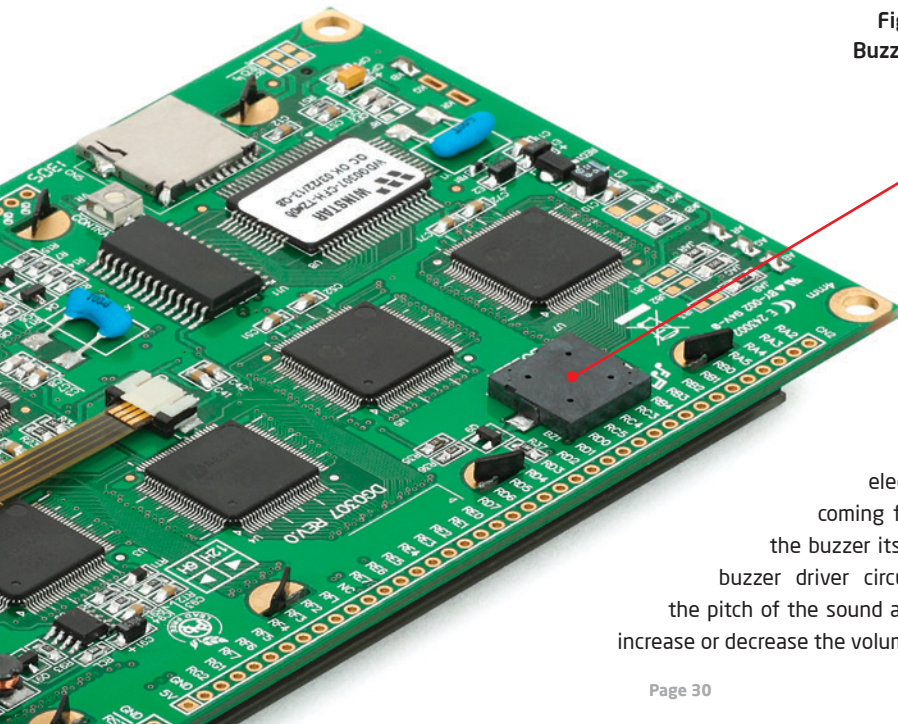
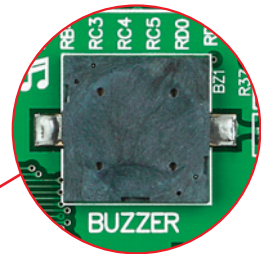

Figure 13-1:  
Buzzer module



The board is also equipped with piezo buzzer. It is an electric component which can be used to create sound when provided with electrical signal. This is usually a PWM signal coming from a microcontroller pin. Before entering the buzzer itself, the signal is amplified by the on-board buzzer driver circuit. Frequency of the signal determines the pitch of the sound and duty cycle of the signal can be used to increase or decrease the volume.

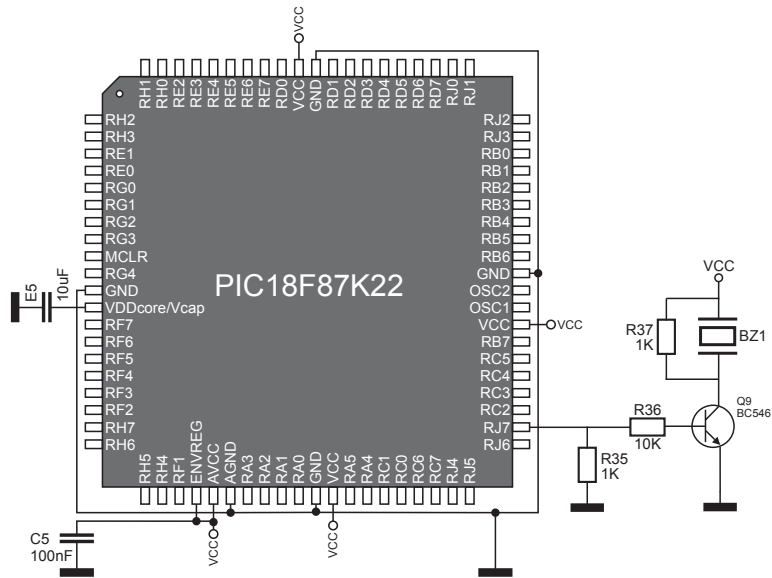
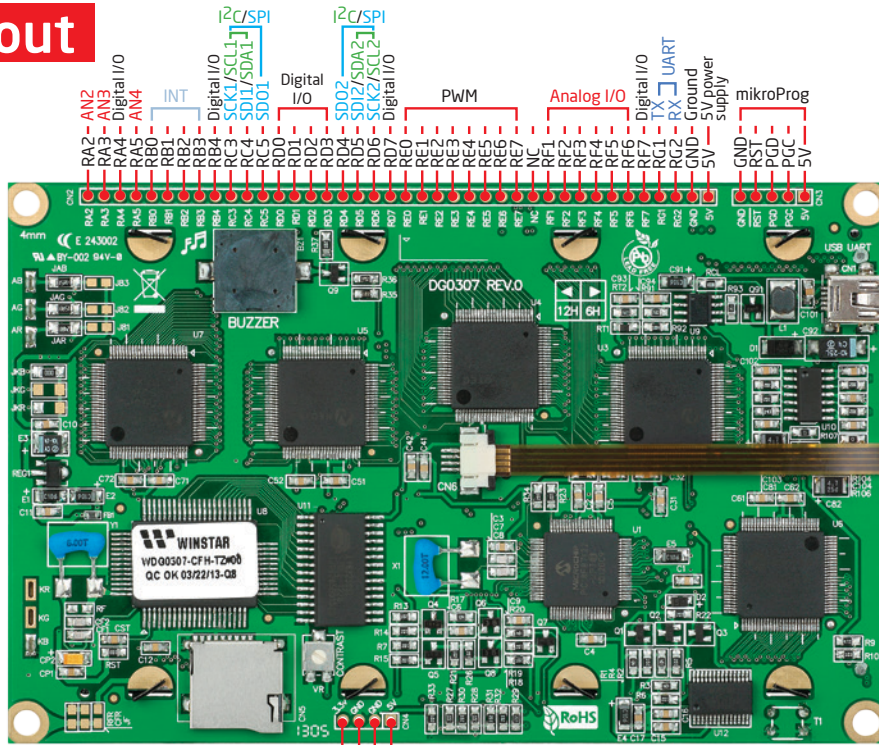

Figure 13-2: Buzzer module schematic

# 14. Pinout



3.3V power supply output  
Ground

5V power supply  
Ground

- Analog Lines
- Interrupt Lines
- SPI Lines
- I2C Lines
- UART lines

# 15. Dimensions

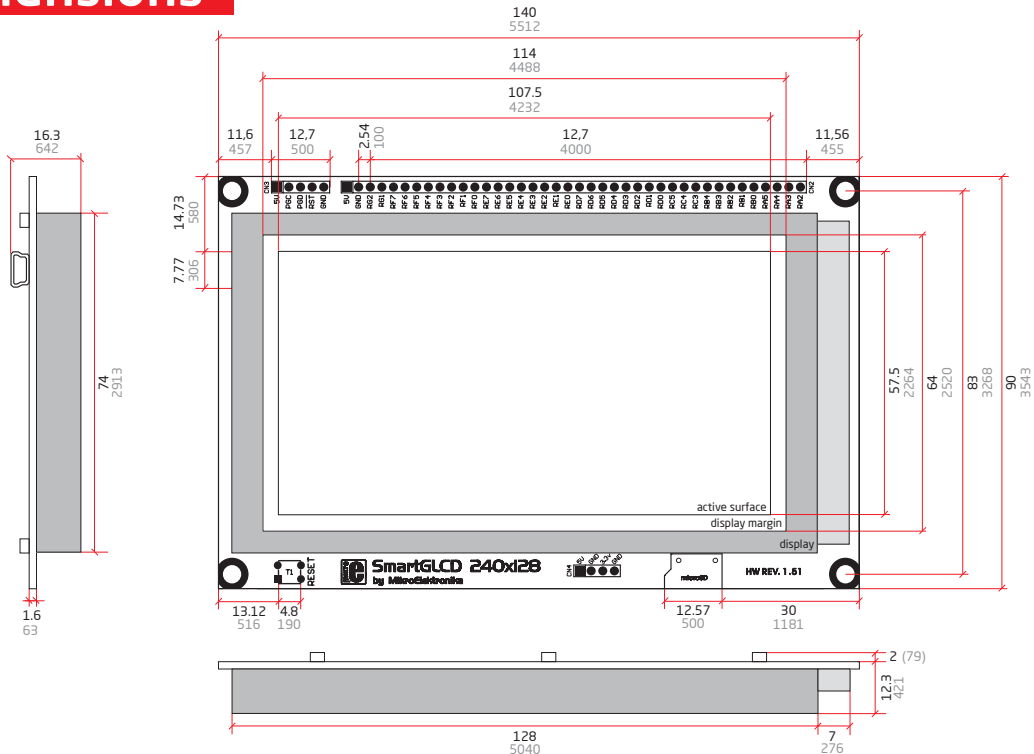

## Legend

— mm  
 — mils

## Pad hole size

Ø 1.14 mm  
 Ø 45 mils

## Mounting hole size

Ø 4 mm  
 Ø 157 mils

Tolerance +/- 0.5mm

# What's next?

Your journey through each and every feature of SmartGLCD board ends here. You got to know it's modules and organization. Now you are ready to use it. We are suggesting several steps which are probably the best way to begin with. We invite you to join the users of SmartGLCD brand. You will find very useful projects and tutorials and can get help from a large ecosystem of users. Welcome!

## Compiler

You still don't have an appropriate compiler? Locate PIC® compiler that suits you best on the Product DVD provided with the package:

*DVD://download/eng/software/compilers/*

Choose between mikroC™, mikroBasic™ and mikroPascal™ and download fully functional demo version, so you can begin building your first applications.



## Projects

Once you have chosen your compiler, and since you already got the board, you are ready to start writing your first projects. **Visual GLCD software** for rapid development of graphical user interfaces enables you to quickly create your GUI. It will automatically create necessary code which is compatible with mikroElektronika compilers. Visual GLCD is rich with examples, which are an excellent starting point for your future projects. Just load the example, read well commented code, and see how it works on hardware. Visual GLCD is also available on the Product DVD.

## DISCLAIMER

All the products owned by MikroElektronika are protected by copyright law and international copyright treaty. Therefore, this manual is to be treated as any other copyright material. No part of this manual, including product and software described herein, may be reproduced, stored in a retrieval system, translated or transmitted in any form or by any means, without the prior written permission of MikroElektronika. The manual PDF edition can be printed for private or local use, but not for distribution. Any modification of this manual is prohibited.

MikroElektronika provides this manual 'as is' without warranty of any kind, either expressed or implied, including, but not limited to, the implied warranties or conditions of merchantability or fitness for a particular purpose.

MikroElektronika shall assume no responsibility or liability for any errors, omissions and inaccuracies that may appear in this manual. In no event shall MikroElektronika, its directors, officers, employees or distributors be liable for any indirect, specific, incidental or consequential damages (including damages for loss of business profits and business information, business interruption or any other pecuniary loss) arising out of the use of this manual or product, even if MikroElektronika has been advised of the possibility of such damages. MikroElektronika reserves the right to change information contained in this manual at any time without prior notice, if necessary.

## HIGH RISK ACTIVITIES

The products of MikroElektronika are not fault - tolerant nor designed, manufactured or intended for use or resale as on - line control equipment in hazardous environments requiring fail - safe performance, such as in the operation of nuclear facilities, aircraft navigation or communication systems, air traffic control, direct life support machines or weapons systems in which the failure of Software could lead directly to death, personal injury or severe physical or environmental damage ('High Risk Activities'). MikroElektronika and its suppliers specifically disclaim any expressed or implied warranty of fitness for High Risk Activities.

## TRADEMARKS

The MikroElektronika name and logo, the MikroElektronika logo, mikroC™, mikroBasic™, mikroPascal™, mikroProg™, mikroBUS™, Click Boards™, EasyPIC and mikromedia™ are trademarks of MikroElektronika. All other trademarks mentioned herein are property of their respective companies.

All other product and corporate names appearing in this manual may or may not be registered trademarks or copyrights of their respective companies, and are only used for identification or explanation and to the owners' benefit, with no intent to infringe.



If you want to learn more about our products, please visit our website at [www.mikroe.com](http://www.mikroe.com)

If you are experiencing some problems with any of our products or just need additional information, please place your ticket at [www.mikroe.com/esupport](http://www.mikroe.com/esupport)

If you have any questions, comments or business proposals,  
do not hesitate to contact us at [office@mikroe.com](mailto:office@mikroe.com)

SmartGLCD 240x128 Manual  
ver. 1.51

