

HFMD/HFMDT - SERIES

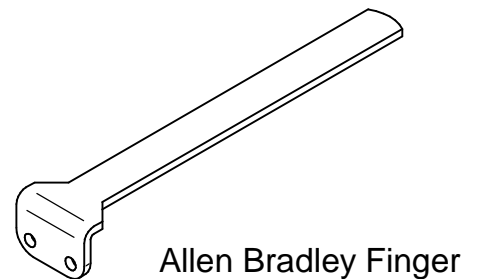
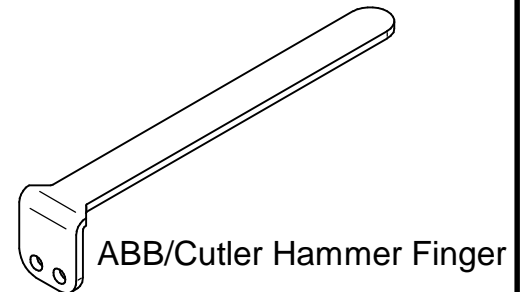
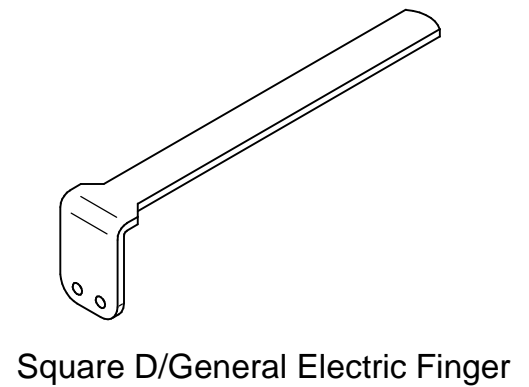
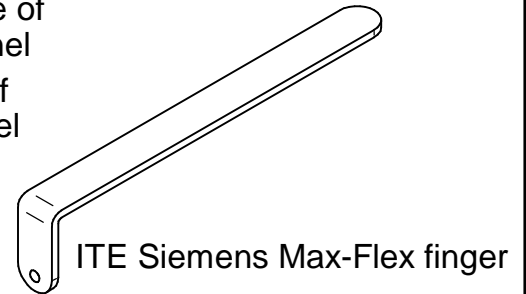
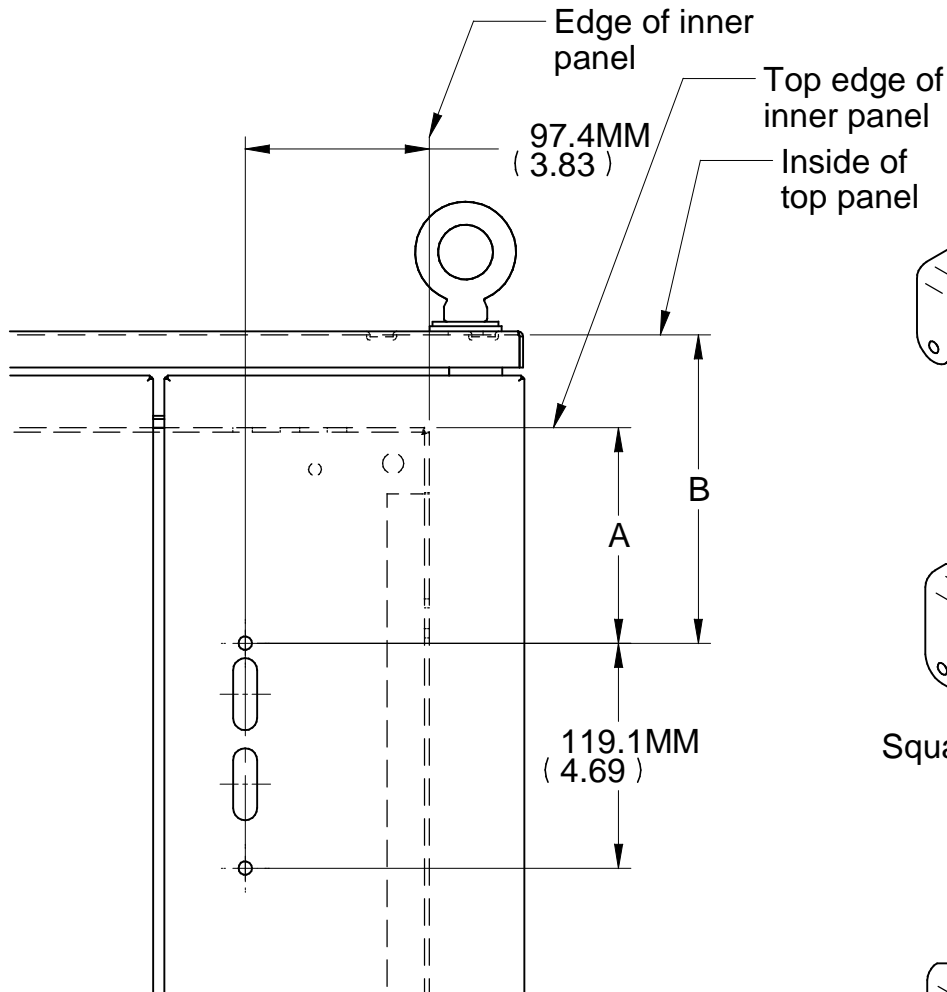

BUL86334

REV. A

ASSEMBLY INSTRUCTIONS FOR HFMD/HFMDT flange disconnect kit



HME Height	A	B
1400MM	114.2MM (4.50)	163.2MM (6.43)
1600MM	214.2MM (8.43)	263.2MM (10.36)
1800MM	314.2MM (12.37)	363.2MM (14.30)
2000MM	414.2MM (16.31)	463.2MM (18.24)
2200MM	514.2MM (20.24)	563.2MM (22.17)

<p>TOOL BOX</p> 	<p>Phillips Screw Driver</p> 
---	--



HFMD/HFMDT - SERIES

BUL86334

REV. A

ASSEMBLY INSTRUCTIONS FOR HFMD/HFMDT flange disconnect kit

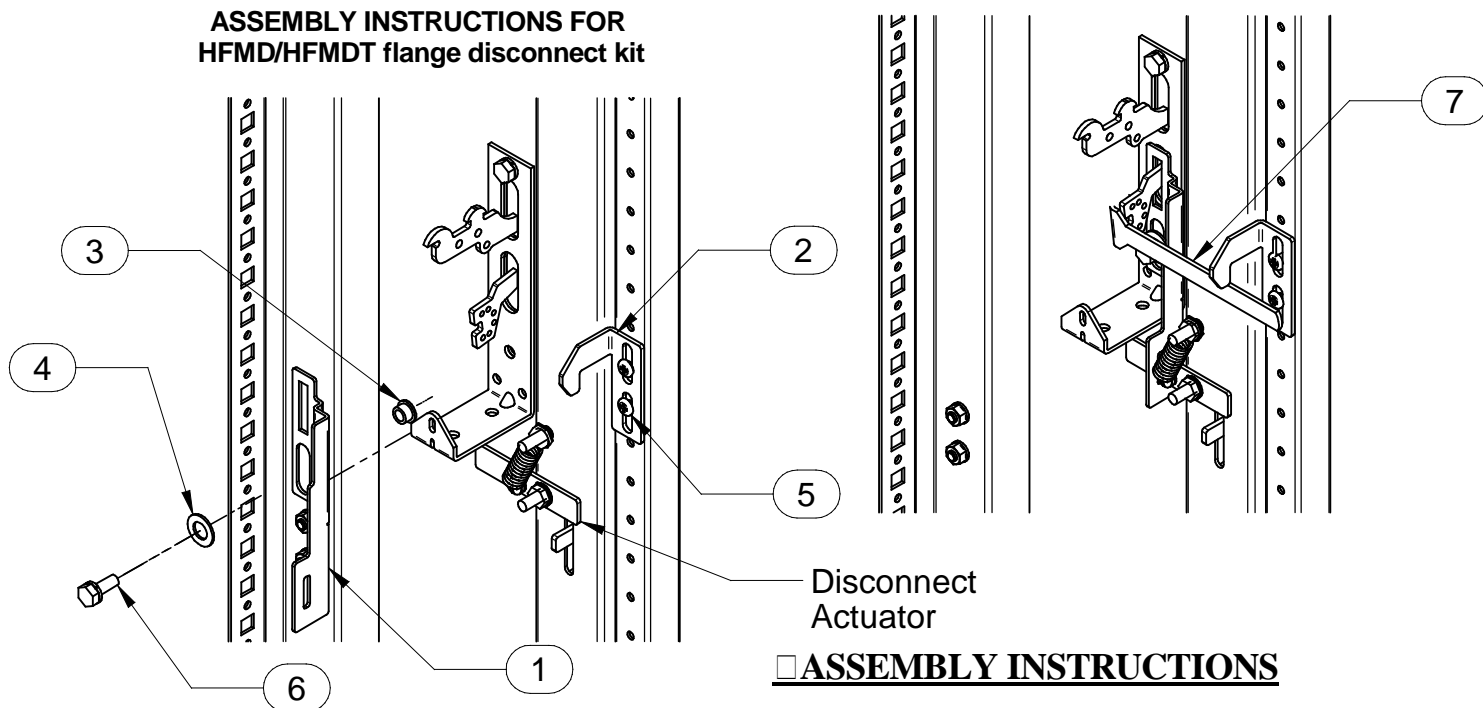

ASSEMBLY INSTRUCTIONS

A) Refer to the handle operator instructions for proper installation of the handle.

B) Remove the bottom screw from the handle operator. Slide the slide arm (item 1) over the disconnect actuator and the lower arm of the handle. Install the nylon bushing (item 3) into the back side of the slide arm (item 1). Use the screw from the handle and the supplied washer (item 4) and insert it through the nylon bushing (item 3) and into the handle. If the screw that comes with the handle is too short use the supplied screw (item 6) and the lock washer from the handle screw.

C) Install the correct HFMD finger (item 7) (refer to page 1) with the hardware supplied with the handle.

D) Install the door hook (item 2) on the door frame using two threadrolling screws (item 5).

E) Test function of the disconnect by having the master door closed, handle in the "ON" position (test before power is added to the unit). Open master door, the HFMD finger (item 7) should engage the door hook (item 2) and not allow the master door to open. Switch handle to "OFF" position and master door should open.

ITEM	DESCRIPTION	QTY
1	HFMD SLIDE ARM	1
2	HFMD - DOOR HOOK	1
3	NYLON BUSHING	1
4	WASHER - 13/32 X 47/64 FLAT ZP	1
5	SCREW - #12 X 1/2" PAN HEAD PHILLIPS SELF TAPPING	2
6	1/4-20 X 3/4 HEX BOLT	1
7	HFMD - FINGER	4

