

Multi-stage EMI Filter



- Rated currents from 6 to 30 A
- Surge pulse protection up to 2 kA
- Solder or screw connection



Performance indicators

Attenuation performance



Rated current [A]

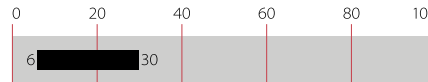

Approvals



Features and benefits

- FN 352 Z series is developed to meet high filter attenuation requirements by using multi-stage filter design
- Additional high surge pulse voltage protection up to 2 kA is integrated to protect sensitive equipment
- Choosing FN 352 Z product line brings you the rapid availability of a standard filter associated with the necessary safety acceptances
- Standard filters are a practical solution helping you to pass EMI system approval in a short time
- Exceptional conducted attenuation performance, based on multi-stage design and chokes with high saturation resistance and excellent thermal behavior
- Various connection options
- Custom-specific versions on request

Technical specifications

Maximum continuous operating voltage	250 VAC, 50/60 Hz
Operating frequency	DC to 400 Hz
Rated currents	6 to 30 A @ 40°C max.
High potential test voltage	P → PE 2000 VAC for 2 sec P → N 350 VDC for 2 sec
Energy absorption	40J
Temperature range (operation and storage)	-25°C to +85°C (25/85/21)
Flammability corresponding to	UL 94 V-2 or better
Design corresponding to	UL 1283, CSA 22.2 No. 8 1986, IEC/EN 60939
MTBF @ 40°C/230 V (Mil-HB-217F)	230,000 hours
Surge pulse protection	2 kV IEC 61000-4-5

Typical applications

- Facility management
- Industrial
- Telecommunication
- Data processing
- Electrical and electronic equipment

Typical electrical schematic

6A types

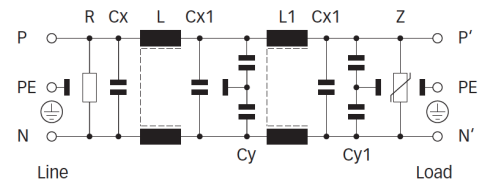

10 to 30A types

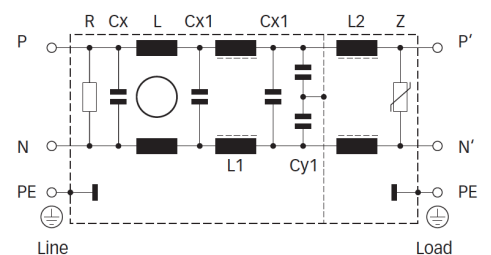

Filter selection table

Filter	Rated current @ 40°C (25°C) [A]	Leakage current* @ 230 VAC/50 Hz [µA]	Inductance			Capacitance				Resistance R [MΩ]	Energy absorption [J]	Input/Output connections	Weight [g]
			L [mH]	L1 [mH]	L2 [mH]	Cx [nF]	Cx1 [nF]	Cy [nF]	Cy1 [nF]				
FN 352 Z-6-06	6 (7.2)	420	3	3		470	220	3.3	1.5	0.47	40	-06	575
FN 352 Z-10-29	10 (12)	1300	5	0.06	0.003	220	220	15	15	0.47	40	-29	1320
FN 352 Z-20-29	20	1300	3.5	0.06	0.0035	220	220	15	15	0.47	40	-29	2950
FN 353 Z-30-33	24 (30)	1300	2.3	0.025	0.035	470	220	15	15	0.23	40	-33	3100

* Maximum leakage under normal operating conditions.
Note: if the neutral line is interrupted, worst case leakage could reach twice this level.

Typical filter attenuation

Per CISPR 17; A=50 Ω/50 Ω sym; B=50 Ω/50 Ω asym; C=0.1 Ω/100 Ω sym; D=100 Ω/0.1 Ω sym

6 A types

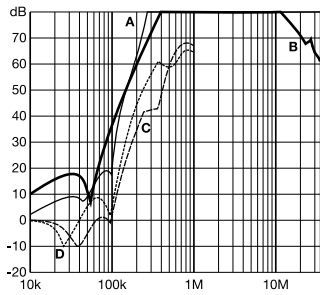

10 A types

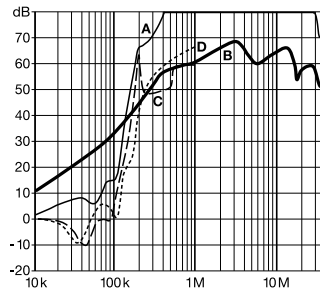

20 A types

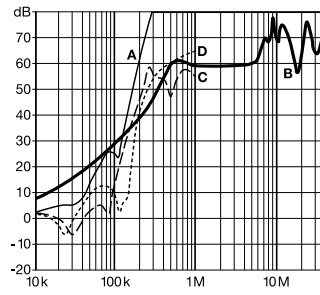

30 A types

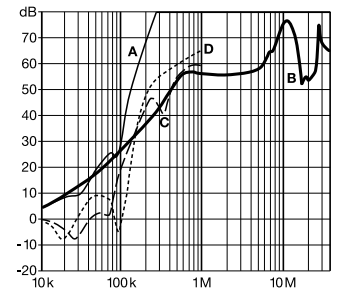

Mechanical data

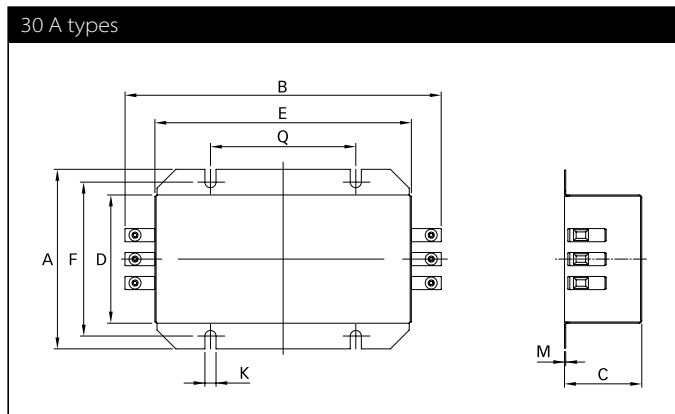
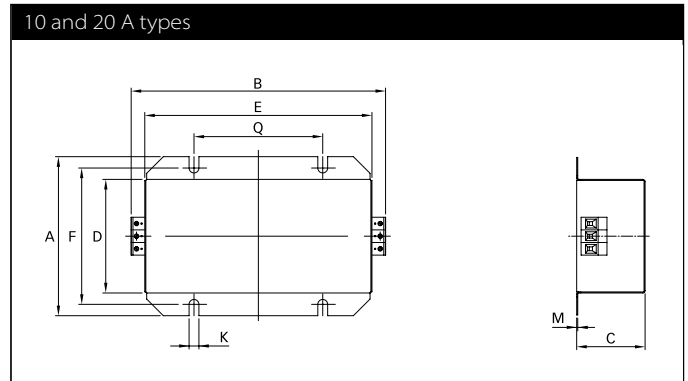
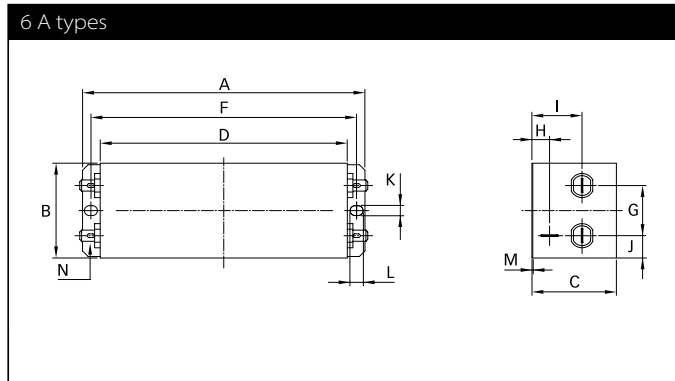

Dimensions

	6 A	10 A	20 A	30 A	Tolerances
A	152	126	150	150	±0.5
B	51	172.3	221.8	250	±0.5
C	45	55.25	65	65	±0.5
D	133	100.5	119.5	119.5	±0.5
E		150.5	200	200	±0.5
F	143	112	135	135	±0.5
G	27				±0.5
H	9.5				±0.5
I	27				±0.5
J	12				±0.5
K	5.3	6.4	6.4	6.4	
L	7				
M	0.5				
N	6.3 x 0.8				
Q		85	115	115	±0.1

All dimensions in mm; 1 inch = 25.4 mm
Tolerances according: ISO 2768-m/EN 22768-m

Filter input/output connector cross sections

	-06	-29	-33
Solid wire	n/a	6 mm ²	16 mm ²
Flex wire	n/a	4 mm ²	10 mm ²
AWG type wire	n/a	AWG 10	AWG 6
Recommended torque	n/a	0.6-0.8 Nm	1.5-1.8 Nm

Please visit www.schaffner.com to find more details on filter connectors.



Headquarters, global innovation and development

Switzerland

Schaffner Group

Nordstrasse 11
4542 Luterbach
T +41 32 681 66 26
info@schaffner.com
<http://www.schaffner.com>



Sales and application centers

China

Schaffner EMC Ltd. Shanghai

T20-3 C, No 565 Chuangye Road,
Pudong district
201201 Shanghai
T +86 21 3813 9500
cschina@schaffner.com
<http://www.schaffner.com.cn>

Finland

Schaffner Oy

Sauvonrinne 19 H
08500 Lohja
T +358 50 468 7284
finlandsales@schaffner.com

France

Schaffner EMC S.A.S.

16-20 Rue Louis Rameau
95875 Bezons
T +33 1 34 34 30 60
F +33 1 39 47 02 28
francesales@schaffner.com

Germany

Schaffner Deutschland GmbH

Schoemperlenstrasse 12B
76185 Karlsruhe
T +49 721 56910
F +49 721 569110
germanysales@schaffner.com

India

Schaffner India Pvt. Ltd

Unit 59, Level, Mfar Greenheart 7
Manyata Tech Park, Hebbal Outer Ring Road
560045 Bangalore
T +91 80 6781 9805
F +91 80 6781 9998
indiasales@schaffner.com

Italy

Schaffner EMC S.r.l.

Via Ticino, 30
20900 Monza (MB)
T +39 039 21 41 070
italysales@schaffner.com

Japan

Schaffner EMC K.K.

1-32-12, Kamiyama, Setagaya-ku
7F Mitsui-seimei Sengenjaya Bldg.
154-0011 Tokyo
T +81 3 5712 3650
F +81 3 5712 3651
japansales@schaffner.com
<http://www.schaffner.jp>

Singapore

Schaffner EMC Pte Ltd.

#05-09, Kg Ubi Ind. Estate
408705 Singapore
T +65 6377 3283
F +65 6377 3281
singaporesales@schaffner.com

Spain

Schaffner EMC España

Calle Caléndula 93, Miniparc III, Edificio E
El Soto de Moraleja, Alcobendas
28109 Madrid
T +34 917 912 900
F +34 917 912 901
spainsales@schaffner.com

Sweden

Schaffner EMC AB

Tegeluddsvägen 76, 2tr
115 28 Stockholm
T +46 8 5050 2425
swedensales@schaffner.com
<http://www.schaffner.com>

Switzerland

Schaffner EMV AG

Nordstrasse 11
4542 Luterbach
T +41 32 681 66 26
switzerlandsales@schaffner.com

Taiwan R.O.C.

Schaffner EMV Ltd.

20 Floor-2, No 97, Section 1, XinTai 5th Road
22175 XiZhi District New Taipei City 22175
T +886 2 2697 5500
F +886 2 2697 5533
taiwansales@schaffner.com
<http://www.schaffner.com.tw>

Thailand

Schaffner EMC Co. Ltd.

Northern Region Industrial Estate
67 Moo 4 Tambon Ban Klang
Amphur Muangng P.O. Box 14
51000 Lamphun
T +66 53 58 11 04
F +66 53 58 10 19
thailandsales@schaffner.com

United Kingdom

Schaffner Ltd.

5 Ashville Way, Molly Millars Lane
Wokingham
RG41 2PL Berkshire
T +44 118 9770070
F +44 118 9792969
uksales@schaffner.com

USA

Schaffner EMC Inc.

52 Mayfield Avenue
08837 Edison, New Jersey
T +1 800 367 5566
T +1 732 225 9533
F +1 732 225 4789
usasales@schaffner.com
<http://www.schaffnerusa.com>

Schaffner North America

6722 Thirlane Road
24019 Roanoke, Virginia
T +1 276 228 7943
F +1 276 228 7953

Schaffner North America

823 Fairview Road
24382 Wytheville, Virginia
T +1 276 228 7943
F +1 276 228 7258

To find your local partner within Schaffner's global network: www.schaffner.com

© 2017 Schaffner Group

The content of this document has been carefully checked and understood. However, neither Schaffner nor its subsidiaries assume any liability whatsoever for any errors or inaccuracies of this document and the consequences thereof. Published specifications are subject to change without notice. Product suitability for any area of application must ultimately be determined by the customer. In all cases, products must never be operated outside their published specifications. Schaffner does not guarantee the availability of all published products. This disclaimer shall be governed by substantive Swiss law and resulting disputes shall be settled by the courts at the place of business of Schaffner Holding AG. Latest publications and a complete disclaimer can be downloaded from the Schaffner website. All trademarks recognized.