



User Manual

MIO-5350

**Intel[®] Pentium N4200 Celeron N3350
& Atom[™] E3950/E3940/E3930, 3.5"
MI/O-Compact SBC, DDR3L, VGA, /
DP*, 48-bit LVDS/eDP*, 2GbE, Mini
PCIe, mSATA, iManager,
M.2 E Key, *TPM 2.0, MIOe**

ADVANTECH

Enabling an Intelligent Planet

Copyright

The documentation and the software included with this product are copyrighted 2017 by Advantech Co., Ltd. All rights are reserved. Advantech Co., Ltd. reserves the right to make improvements in the products described in this manual at any time without notice. No part of this manual may be reproduced, copied, translated or transmitted in any form or by any means without the prior written permission of Advantech Co., Ltd. Information provided in this manual is intended to be accurate and reliable. However, Advantech Co., Ltd. assumes no responsibility for its use, nor for any infringements of the rights of third parties, which may result from its use.

Acknowledgements

Intel® is a trademark of Intel® Corporation.

AMI is a trademark of American Megatrends, Inc.

IBM, PC, PS/2 and VGA are trademarks of International Business Machines Corporation.

Microsoft Windows®, DirectX® is a registered trademark of Microsoft Corp.

All other product names or trademarks are properties of their respective owners.

For more information on this and other Advantech products, please visit our websites at:

<http://www.advantech.com>

<http://www.advantech.com/eplatform>

For technical support and service, please visit our support website at:

<http://support.advantech.com/>

This manual is for the MIO-5350.

Product Warranty (2 years)

Advantech warrants to you, the original purchaser, that each of its products will be free from defects in materials and workmanship for two years from the date of purchase.

This warranty does not apply to any products which have been repaired or altered by persons other than repair personnel authorized by Advantech, or which have been subject to misuse, abuse, accident or improper installation. Advantech assumes no liability under the terms of this warranty as a consequence of such events.

Because of Advantech's high quality-control standards and rigorous testing, most of our customers never need to use our repair service. If an Advantech product is defective, it will be repaired or replaced at no charge during the warranty period. For out-of-warranty repairs, you will be billed according to the cost of replacement materials, service time and freight. Please consult your dealer for more details.

If you think you have a defective product, follow these steps:

1. Collect all the information about the problem encountered. (For example, CPU speed, Advantech products used, other hardware and software used, etc.) Note anything abnormal and list any onscreen messages you get when the problem occurs.
2. Call your dealer and describe the problem. Please have your manual, product, and any helpful information readily available.
3. If your product is diagnosed as defective, obtain an RMA (return merchandise authorization) number from your dealer. This allows us to process your return more quickly.
4. Carefully pack the defective product, a fully-completed Repair and Replacement Order Card and a photocopy proof of purchase date (such as your sales receipt) in a shippable container. A product returned without proof of the purchase date is not eligible for warranty service.
5. Write the RMA number visibly on the outside of the package and ship it prepaid to your dealer.

Declaration of Conformity

CE

This product has passed the CE test for environmental specifications. Test conditions for passing included the equipment being operated within an industrial enclosure. In order to protect the product from being damaged by ESD (Electrostatic Discharge) and EMI leakage, we strongly recommend the use of CE-compliant industrial enclosure products.

FCC Class B

Note: This equipment has been tested and found to comply with the limits for a Class B digital device, pursuant to part 15 of the FCC Rules. These limits are designed to provide reasonable protection against harmful interference in a residential installation. This equipment generates, uses and can radiate radio frequency energy and, if not installed and used in accordance with the instructions, may cause harmful interference to radio communications. However, there is no guarantee that interference will not occur in a particular installation. If this equipment does cause harmful interference to radio or television reception, which can be determined by turning the equipment off and on, the user is encouraged to try to correct the interference by one or more of the following measures:

- Reorient or relocate the receiving antenna.
- Increase the separation between the equipment and receiver.
- Connect the equipment into an outlet on a circuit different from that to which the receiver is connected.
- Consult the dealer or an experienced radio/TV technician for help.

Caution! *There is a danger of a new battery exploding if it is incorrectly installed. Do not attempt to recharge, force open, or heat the battery. Replace the battery only with the same or equivalent type recommended by the manufacturer. Discard used batteries according to the manufacturer's instructions.*



Technical Support and Assistance

1. Visit the Advantech website at <http://support.advantech.com> where you can find the latest information about the product.
2. Contact your distributor, sales representative, or Advantech's customer service center for technical support if you need additional assistance. Please have the following information ready before you call:
 - Product name and serial number
 - Description of your peripheral attachments
 - Description of your software (operating system, version, application software, etc.)
 - A complete description of the problem
 - The exact wording of any error messages

Packing List

Before you begin installing your card, please make sure that the following materials have been shipped:

- 1 x MIO-5350 SBC
- 1 x SATA Cable 30cm (p/n: 1700006291)
- 1 x SATA Power Cable 35cm (p/n: 1700018785)
- 1 x Audio Cable 20cm (p/n: 1700019584)
- 2 x COM Cable 22cm (p/n: 1701200220)
- 1 x Heatsink (19mm) (p/n: 1960078474T001)
- 1 x Startup manual (p/n: 2006535000)
- 1 x Mini Jumper(10pcs package) (p/n: 9689000002)
- 1 x Screw Kit (4pcs screws for miniPCIe) (p/n: 9666525100E)
- 1 x SUSIAccess Pro package (p/n: 968EMLSAP1)

If any of these items are missing or damaged, contact your distributor or sales representative immediately.

Optional MIOe Module

Part Number	Description
MIOe-210-D6A1E	4 x RS232/422/485, 2x RS422/485, 8-bit GPIO
MIOe-220-B3A1E	3 x Intel® Gigabit Ethernet with PCIe Switch
MIOe-230-L0A1E	DisplayPort or 48-bit LVDS, 2 x USB2.0
MIOe-DB5000-01A1E	MI/O extension evaluation board
MIOe-3674-AE	4-port PoE ports
MIOe-3680-AE	2-Port CAN-Bus with Isolation Protection
MIOe-PWR1-00E	12-24V wide range power module (by cable, not via MIOe)
MIOe-PWR2	9-36V wide range power module (by cable, not via MIOe)

Optional Accessories

Part number	Description
1757003995	AC-to-DC Adapter 12V/5A, 0-40°C
1703100264	Internal 1-Port USB cable 22.5cm

Contents

Chapter 1	General Information	1
1.1	Introduction	2
1.2	Specifications	2
1.2.1	Functional Specifications	2
1.2.2	OS support.....	4
1.2.3	Mechanical Specifications.....	4
1.2.4	Electrical Specifications	4
1.2.5	Environmental	4
1.3	Block Diagram.....	5
1.4	Board layout: dimensions.....	5
	Figure 1.1 MIO-5350 Mechanical Drawing (Top Side)	5
	Figure 1.2 MIO-5350 Mechanical Drawing (Bottom Side)	6
	Figure 1.3 MIO-5350 Mechanical Drawing (Coastline).....	6
Chapter 2	Installation.....	7
2.1	Jumpers & Switches.....	8
	Table 2.1: Jumpers & Switches	8
2.2	Connectors.....	8
	Table 2.2: Connectors	8
2.3	Locating Connectors	9
	Figure 2.1 MIO-5350 Connector Locations (Top Side).....	9
	Figure 2.2 MIO-5350 Connector Locations (Bottom Side).....	9
2.4	Setting Jumpers	10
Chapter 3	AMI BIOS Setup	13
3.1	Entering Setup	15
3.1.1	Main Setup.....	15
3.1.2	Advanced BIOS Features Setup.....	16
3.1.3	Chipset Configuration	28
3.1.4	Security	36
3.1.5	Boot.....	37
3.1.6	Save & Exit	38
Chapter 4	MIOe Installation	39
4.1	Quick Installation Guide:	40
Appendix A	Pin Assignments	41
A.1	Jumper List.....	42
A.2	Connectors.....	44
	Table A.1: Connectors	44
Appendix B	System Assignments	63
B.1	System I/O Ports	64
	Table B.1: System I/O Ports	64
B.2	1st MB Memory Map	64

	Table B.2: 1st MB Memory Map	64
B.3	Interrupt Assignments	65
	Table B.3: Interrupt assignments.....	65

Appendix C **EC Watchdog Timer Sample Code .. 67**

C.1	EC Watchdog Timer sample code	68
-----	-------------------------------------	----

Chapter 1

General Information

This chapter gives background information on the MIO-5350.

Sections include:

- Introduction
- Specifications
- Block diagram
- Board layout and dimensions

1.1 Introduction

MIO-5350 is designed using MI/O Extension form factor (compact series, 146 x 102 mm) and powered by the latest generation of Intel® Pentium N4200 Celeron N3350 & Atom™ E3950/E3940/E3930 which have low power features but also good performance computing, especially for multimedia capabilities compared to earlier generations. Meanwhile, MIO-5350 offers flexible expansion possibilities: one full-size mini PCIe, 2nd LVDS through MIOe-230, SIM holder, MIOe with 1 x SMBus, 3 x USB2.0, LPC, 1 x PCIe x1, 1 x line out, DisplayPort*, +5 Vsb/+12 Vsb power, Power On, Rest. MIO-5350 supports various display interfaces including /DisplayPort, VGA, 48-bit LVDS/eDP, and rich I/O: 2 x Intel i210 GbE, 4 x COM, 2 SATA, 2 USB 3.0, 1x SMBus/I2C, 1 x GPIO.

1.2 Specifications

1.2.1 Functional Specifications

■ Processor:

- Intel® Pentium N4200 1.1 GHz (burst frequency 2.5GHz) Quad Core, Four Threads
- Celeron® N3350 1.1(burst frequency 2.4GHZ), Dual Core (burst frequency 2.42GHz), Quad Cores, Four Threads
- Atom™ E3950/40/30, 1.6/1.6/1.3GHz, Quad/Quad/Dual Cores, Two Threads
- Cache Hierarchy
 - * 32 KB 8-way L1 instruction cache and 24 KB 6-way L1 data cache per core
 - * 1 MB, 16-way L2 cache, shared per two cores
- Supported C-states: C0, C1, C6, C7
- Advanced Technologies
 - * Intel® Virtualization Technology (VT-x)
 - * Intel® 64 Architecture
 - * Enhanced Intel SpeedStep Technology
 - * Intel® Trusted Execution Engine (TXE)
- Power Management
 - * ACPI 5.0
 - * System sleep states: S0, S3, S4, S5

■ System Memory Support

- Dual Channel ECC, DDR3L SODIMM up to 8GB
- 64 bit data bus
- 2x64 DDR3L 1867
- 4x32 LPDDR4 2400
- 38.4 GB/s (@2400 MT/s); 29.9 GB/s (@1867 MT/s)
- Aggressive power management to reduce power consumption

■ Graphic and Media Engine

- Intel® 9th generation (Gen 9) graphics and media encode/decode engine
- GFX:
 - Graphic Features:
 - * 3D HW Acceleration: DirectX* 11.3/12,
 - * 4K Decode for HEVC4, H.264, VP8;
 - * 4K Encode for H.264, VP8
- Multi-display interfaces: VGA, /HDMI (default)/(DP*), 48-bit LVDS/eDP (default LVDS). MIOe's DisplayPort interface is shared with DisplayPort on rear I/O.

- * Supports Extend/ Clone Mode with multi-display device
- * Dual display: any two combination between VGA, /HDMI/DP/MIOe's DisplayPort, LVDS/eDP
- Specification and Resolution
 - * VGA port:CH7517A-BF Maximum Resolution up to 1920x1200
 - * or DP*-DP 1.2a (4096x2160@60Hz)/ 1.4b (3840x2160@30Hz)
 - * eDP v1.4 4096x2160@ 60Hz / LVDS 48bit:
 - * Inverter power: 1A @ 5V/12V
- 3D HW Acceleration: OpenGL* 4.2, DirectX* 12, OpenCL* 2.0
- HW Video Decode: H.264,VC-1, WMV9, H.265/HEVC,VP8, VP9, JPEG/ MJPEG
- HW Video Encode: H.264,MVC, H.265/HEVC, VP8, VP9, JPEG/MJPEG
- **Gigabit Ethernet**
 - Controller: Intel® i210
 - * 10/100/1000 BASE-T
 - * IEEE 802.3az Energy Efficient Ethernet (EEE), which defines Low Power Idle (LPI) state
 - * IEEE 1588/802.1AS precision time synchronization
 - * 9.5 KB Jumbo frames supported (Full-duplex)
 - * Flow Control supported
 - * Magic packet wake-up enable with unique MAC address
- **Peripheral interface**
 - MIOe Expansion
 - * DisplayPort (Supported by T-P/N due to shared with the DisplayPort on rear I/O)
 - * 1 PCIe x1
 - * 3 USB 2.0
 - * LPC
 - * HD Audio: Line out
 - * SMBus
 - * Power: +5 Vsb/+12 Vsb, Power On, Reset
 - 1 Serial-ATA port, up to 3.0Gb/s transfer rate (300 MB/s), supports independent DMA operation
 - * SATA Power: 5V / 12V
 - 2 x USB 3.0 & 4 x USB 2.0
 - * Two USB3.0 and two USB2.0 on rear I/O, two internal USB2.0
 - * USB3.0 SuperSpeed (SS), implements xHCI software host controller interface
 - * Multiplexed with EHCI controller that are High-Speed/Full-Speed (HS/FS)
 - * USB source: USB3.0 and USB2.0's dual port on rear I/O's USB signal directly from CPU, USB2.0 dual port on rear I/O + internal USB + mini PCIe from USB hub1, mSATA + 3xUSB3.0 for MIOe from USB hub2
 - * Support wake-up from sleeping state S3
 - * Power supply: 0.5A @ 5V for USB2.0, 1A @ 5V for USB3.0
 - 2 RS-232 for COM1/2, 2 RS-232/422/485 for COM3/4 (ESD protection: air gap ±15kV, contact ±8kV)
 - 8-bit Programmable General Purpose Input/ Output from iManager (5V tolerance)
 - 1 SMBus / I²C channel from iManager
 - Watchdog timer: Output System Reset, Programmable counter from 1 ~ 255 minutes/ seconds
 - Mini PCIe / mSATA
 - * 1 Full-size mSATA (with SATA and USB interface)
 - * Power supply: 1.1 A @ 3.3 V, 0.375 A @ 1.5 V

- **High Definition Audio:**
 - Intel® High Definition Audio Interface
 - High Definition Audio Codec with Realtek proprietary loss-less content protection technology
 - Supports 1 Line-input, 1 Line output, 1 Mic-input
- **BIOS**
 - AMI UEFI 64 Mbit, BIOS for 64 or 32bit is different, default version is for 64bit
 - Default setting is UEFI boot

1.2.2 OS support

MIO-5350 supports Win10, Linux Yocto Project BSP, VxWorks, Android 64 bit (Support by request).

For further information about OS support of MIO-5350, please Advantech website: <http://support.advantech.com.tw/> or contact the technical support center.

1.2.3 Mechanical Specifications

- **Dimensions:** 146 x 102 mm (5.7 x 4 inches)
- **Height:** top side 19mm, PCB 1.6mm, bottom side 6.8mm, total 27.4mm
- **Weight:** 0.5 kg (reference weight of total package)

1.2.4 Electrical Specifications

- **Power Requirement:** Single +12V DC \pm 10% power input
- **Power Consumption:**
 - Max load: E3950: 1.16A @ 12V (13.92W)
 - Idle mode: E3950: 0.37A @ 12V (4.44W)
- **Power Consumption Conditions:**
 - Test software: 3DMark 2006
 - Max. load: Measure the maximum current value which system under maximum load (CPU: Top speed, RAM & Graphic: Full loading)
 - Idle mode: Measure the current value when system in windows mode and without running any program
- **RTC Battery:**
 - Typical Voltage: 3.0 V
 - Normal discharge capacity: 210 mAh

1.2.5 Environmental

- **Operating temperature:** 0 ~ 60°C (32 ~ 140°F)
- **Operating Humidity:** 40°C @ 85% RH Non-Condensing
- **Storage Temperature:** Storage temperature: -40~85°C
- **Storage Humidity:** Relative humidity: 95% @ 60°C

1.3 Block Diagram

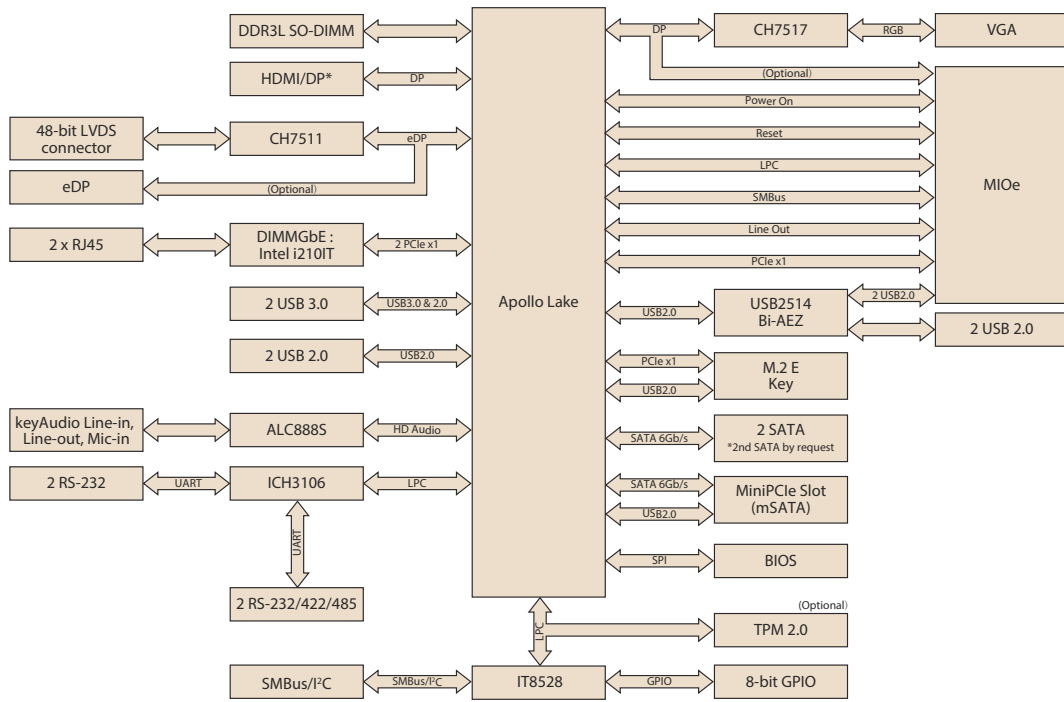

1.4 Board layout: dimensions

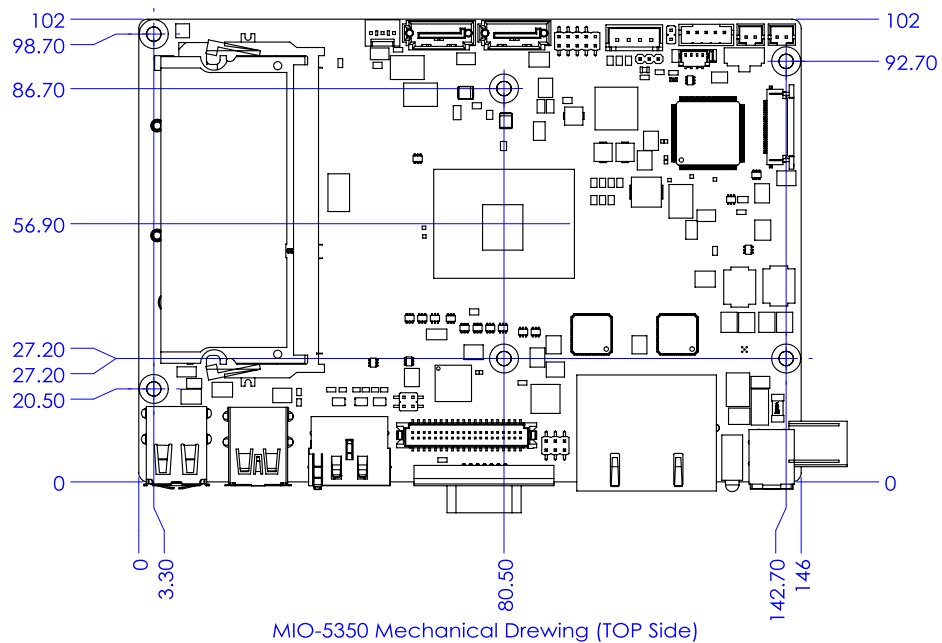

Figure 1.1 MIO-5350 Mechanical Drawing (Top Side)

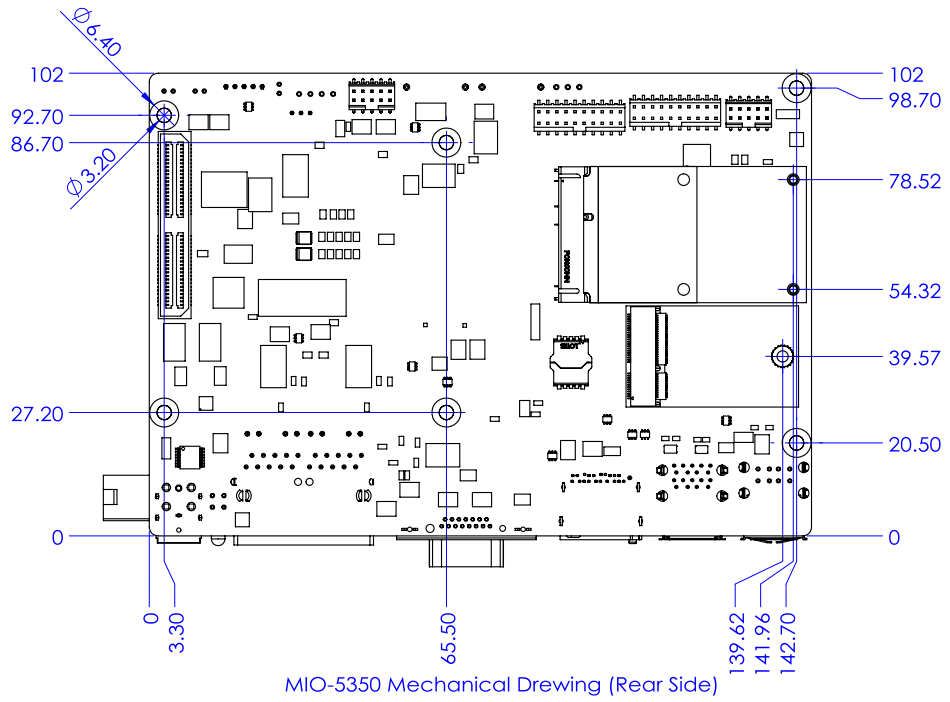

Figure 1.2 MIO-5350 Mechanical Drawing (Bottom Side)

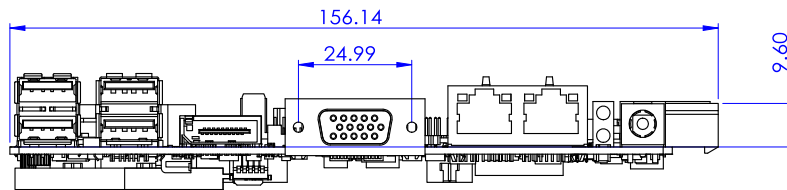

Figure 1.3 MIO-5350 Mechanical Drawing (Coastline)

Chapter 2

Installation

This chapter explains the setup procedures of the MIO-5350 hardware, including instructions on setting jumpers and connecting peripherals, switches and indicators. Be sure to read all safety precautions before you begin the installation procedure.

2.1 Jumpers & Switches

The MIO-5350 has a number of jumpers that allow you to configure your system to suit your application. The table below lists the functions of the various jumpers.

Table 2.1: Jumpers & Switches

J1	Clear CMOS
J2	Auto Power On Setting
J3	LCD Power
J4	LVDS VCON Setting

2.2 Connectors

Onboard connectors link the MIO-5350 to external devices such as hard disk drives, a keyboard, or floppy drives. The table below lists the function of each of the connectors.

Table 2.2: Connectors

Label	Function
CN1	12V Power Input
CN3	Battery
CN4	SODIMDDR3_204
CN5	Power Switch
CN7	Reset
CN8	GPIO
CN9	eDP
CN10	HDMI/DP (Optional)
CN11	VGA
CN12	Inverter Power Output
CN13	48-bit LVDS Panel
CN15	LAN
CN17	Audio
CN18	SATA
CN19	SATA Power
CN20	mSATA
CN22	M.2 E Key
CN23	COM1/COM2
CN24	COM3/COM4/RS422/RS485
CN25	External USB3.0
CN26	External USB2.0
CN27	Internal USB
CN28	MIOe
CN29	+12V FAN
CN30	SMBus
CN31	SATA

2.3 Locating Connectors

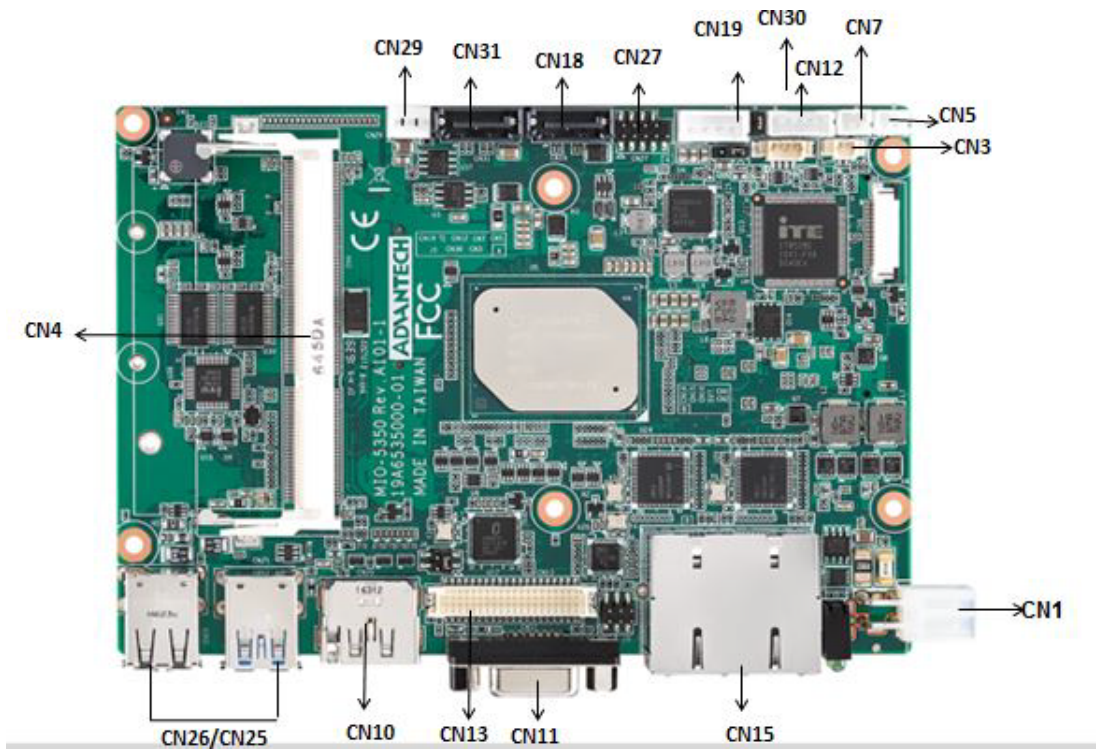

Figure 2.1 MIO-5350 Connector Locations (Top Side)

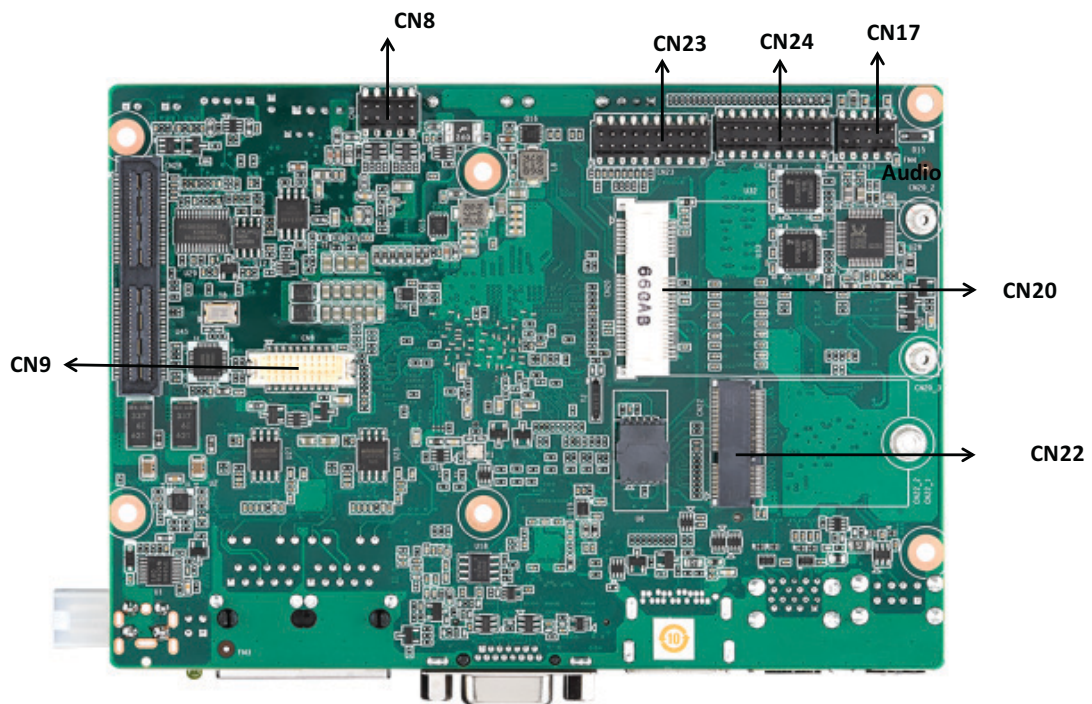
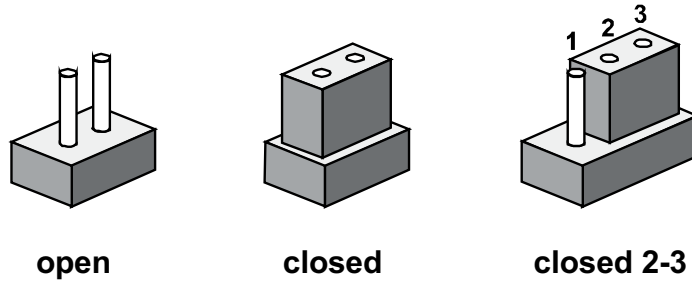

Figure 2.2 MIO-5350 Connector Locations (Bottom Side)

2.4 Setting Jumpers

You may configure your card to match the needs of your application by setting jumpers. A jumper is a metal bridge used to close an electric circuit. It consists of two metal pins and a small metal clip (often protected by a plastic cover) that slides over the pins to connect them. To “close” a jumper, you connect the pins with the clip. To “open” a jumper, you remove the clip. Sometimes a jumper will have three pins, labeled 1, 2 and 3. In this case you would connect either pins 1 and 2, or 2 and 3.

The jumper settings are schematically depicted in this manual as follows:



A pair of needle-nose pliers may be helpful when working with jumpers. If you have any doubts about the best hardware configuration for your application, contact your local distributor or sales representative before you make any changes. Generally, you simply need a standard cable to make most connections.

J1	Clear CMOS
Part Number	1653003101
Footprint	HD_3x1P_79_D
Description	PIN HEADER 3x1P 2.0mm 180D(M) DIP 2000-13 WS
Setting	Function
(1-2)*	Normal
(2-3)	Clear COMS



J2	Auto Power On Setting
Part Number	1653002101-02
Footprint	HD_2x1P_79_D
Description	
Setting	Function
NC	Power Button for Power On
(1-2)*	Auto Power On

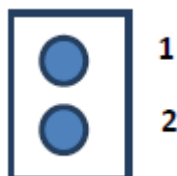

J3	LCD Power
Part Number	1653003260
Footprint	HD_3x2P_79
Description	PIN HEADER 3x2P 2.0mm 180D(M) SMD 21N22050
Setting	Function
(1-3)*	+3.3V
(3-5)	+5V
(3-4)	+12V

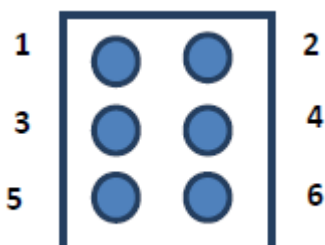

J4	LVDS VCON Setting
Part Number	1653000014
Footprint	HD_2x2P_79
Description	PIN HEADER 2x2P 2.00mm 180D(M) SMD 21N22050
Setting	Function
(1-2)*	3.3V High for VCON on LVDS
(1-3)	Low for VCON on LVDS



Chapter 3

AMI BIOS Setup

With the AMIBIOS Setup program, you can modify BIOS settings and control the various system features. This chapter describes the basic navigation of the MIO-5350 BIOS setup screens.

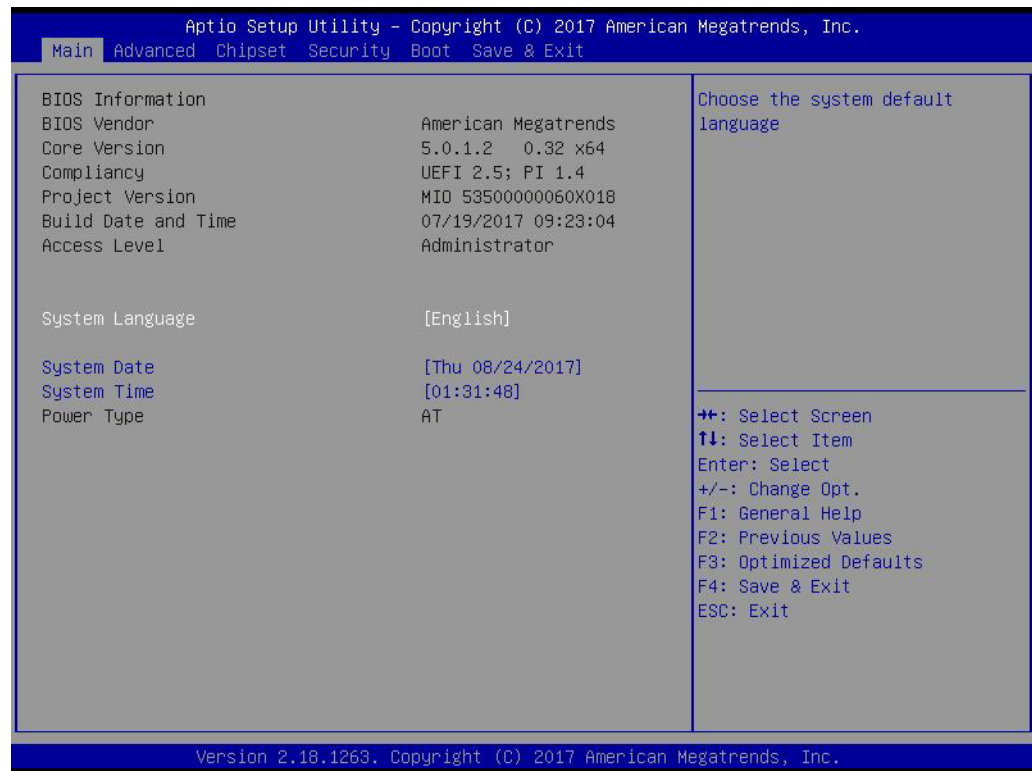

AMI BIOS ROM has a built-in Setup program that allows users to modify the basic system configuration. This information is stored in battery-backed CMOS so it retains the Setup information when the power is turned off.

3.1 Entering Setup

Turn on the computer and check for the patch code. If there is a number assigned to the patch code, it means that the BIOS supports your CPU. If there is no number assigned to the patch code, please contact an Advantech application engineer to obtain an up-to-date patch code file. This will ensure that your CPU's system status is valid. After ensuring that you have a number assigned to the patch code, press and you will immediately be allowed to enter Setup.

3.1.1 Main Setup

When you first enter the BIOS Setup Utility, you will encounter the Main setup screen. You can always return to the Main setup screen by selecting the Main tab. There are two Main Setup options. They are described in this section. The Main BIOS Setup screen is shown below.

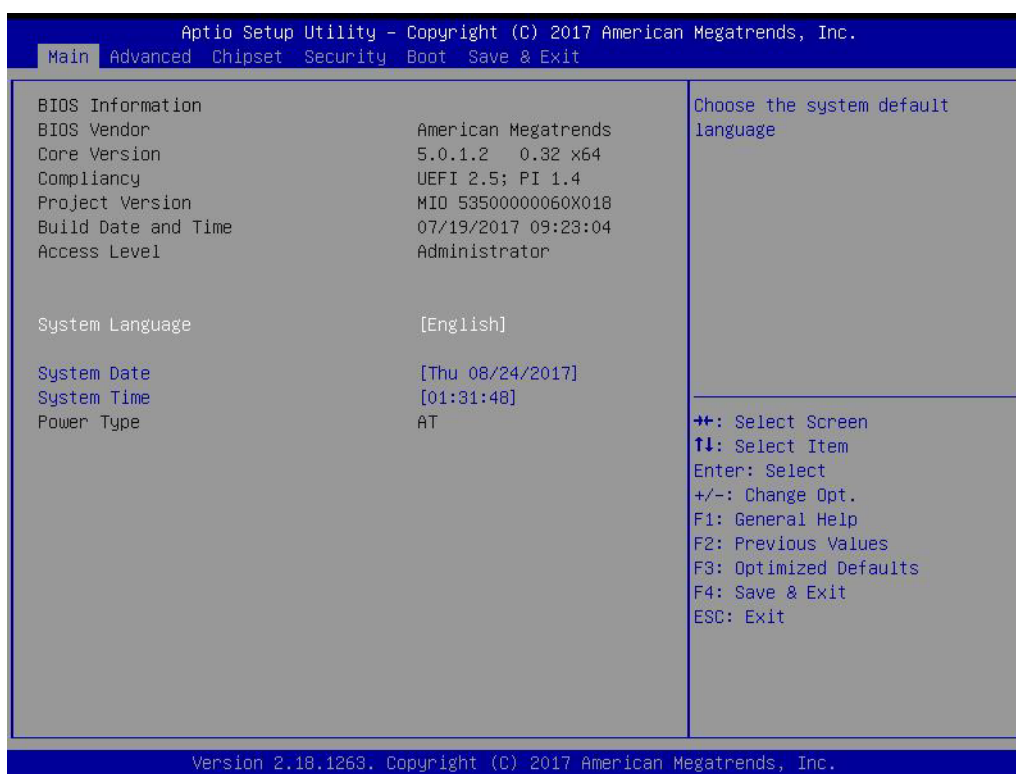

The Main BIOS setup screen has two main frames. The left frame displays all the options that can be configured. Grayed-out options cannot be configured; options in blue can. The right frame displays the key legend.

Above the key legend is an area reserved for a text message. When an option is selected in the left frame, it is highlighted in white. Often a text message will accompany it.

- **System time / System date**

Use this option to change the system time and date. Highlight System Time or System Date using the <Arrow> keys. Enter new values through the keyboard. Press the <Tab> key or the <Arrow> keys to move between fields. The date must be entered in MM/DD/YY format. The time must be entered in HH:MM:SS format.

3.1.2 Advanced BIOS Features Setup

Select the Advanced tab from the MIO-5350 setup screen to enter the Advanced BIOS Setup screen. You can select any of the items in the left frame of the screen, such as CPU Configuration, to go to the sub menu for that item. You can display an Advanced BIOS Setup option by highlighting it using the <Arrow> keys. All Advanced BIOS Setup options are described in this section. The Advanced BIOS Setup screens is shown below. The sub menus are described on the following pages.

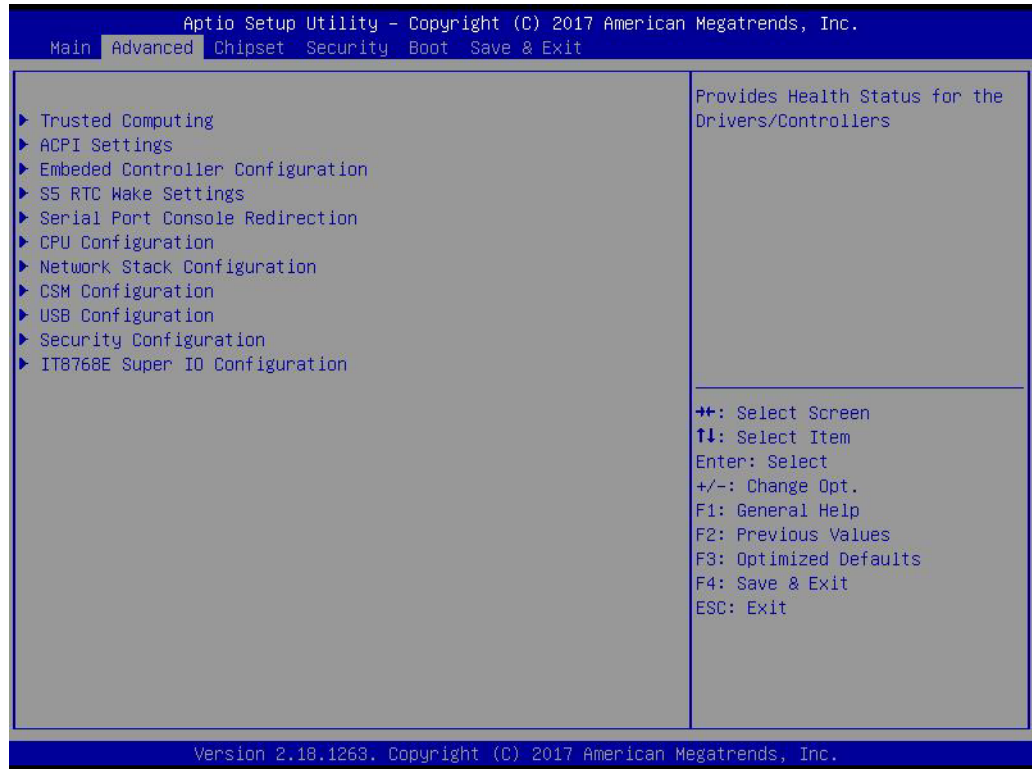

3.1.2.1 Trusted Computing



- **Security Device Support**
Enable or disable BIOS support for security device.
- **SHA-1 PCR Bank**
Enable or Disable SHA-1 PCR Bank.
- **SHA256 PCR Bank**
Enable or Disable SHA256 PCR Bank.
- **Pending operation**
Schedule an Operation for the Security Device.
- **Platform Hierarchy**
Enable or Disable Platform Hierarchy.
- **Storage Hierarchy**
Enable or Disable Storage Hierarchy.
- **Endorsement Hierarchy**
Enable or Disable Endorsement Hierarchy.
- **TPM 2.0 UEFI Spec Version**
Select the TCG2 Spec Version Support.
- **Physical Presence Spec Version**
Select to Tell O.S. to support PPI Spec Version 1.2 or 1.3.
- **Device Select**
TPM 1.2 will restrict support to TPM 1.2 devices, TPM 2.0 will restrict support to TPM 2.0 devices.

3.1.2.2 ACPI Settings

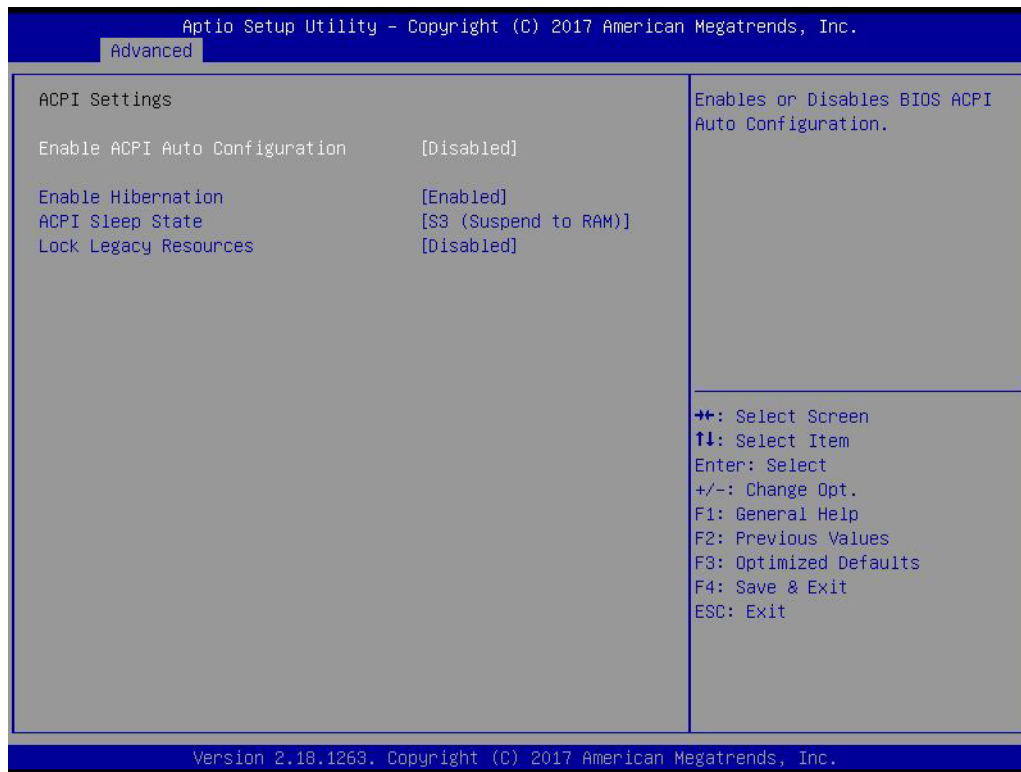

- **Enable ACPI Auto Configuration**
Enable or disable BIOS ACPI auto configuration.
- **Enable Hibernation**
Enables or Disables System ability to Hibernate (OS/S4 Sleep State). This option may be not effective with some OS.
- **ACPI Sleep State**
Select the highest ACPI sleep state the system will enter when the SUSPEND button is pressed.
- **Lock Legacy Resources**
Enables or Disables Lock of Legacy Resources

3.1.2.3 Embedded Controller Configuration

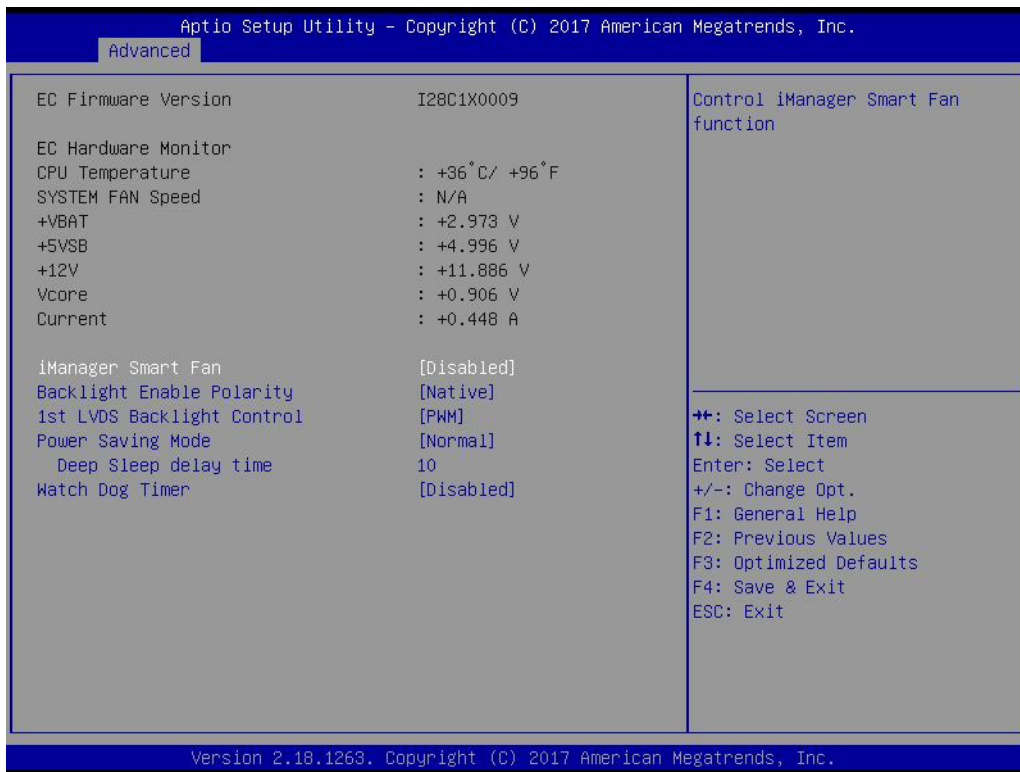

- **EC Hardware Monitor**
This page display all information about system Temperature/Voltage/Current.
- **iManager WatchDog IRQ**
This item allows users to set the IRQ number of EC watchdog.
- **Backlight Enable Polarity**
This item allows users to set backlight mode.
- **1st LVDS Backlight control**
This item allows users to switch Backlight Control for PWM or DC mode.
- **Power Saving Mode**
This item allows users to set board's power saving mode when off.
- **Watch Dog Timer**
This item allows users to select EC watchdog timer.

3.1.2.4 S5 RTC Wake Settings



- **Wake system from S5**
Enable or disable System wake on alarm event. Select FixedTime, system will wake on the hr:min:sec specified.

3.1.2.5 Serial Port Console Redirection

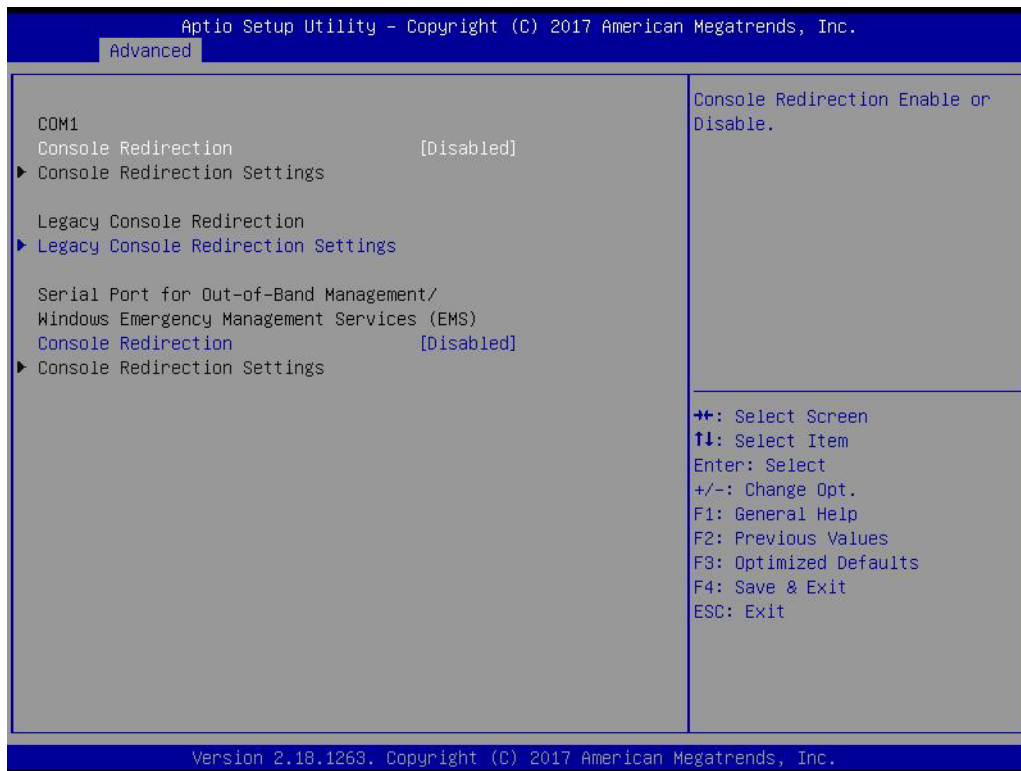

- **Console Redirection**
 This item allows users to enable or disable console redirection for Microsoft Windows Emergency Management Services (EMS).
- **Console Redirection**
 This item allows users to configuration console redirection detail settings.

3.1.2.6 CPU Configuration

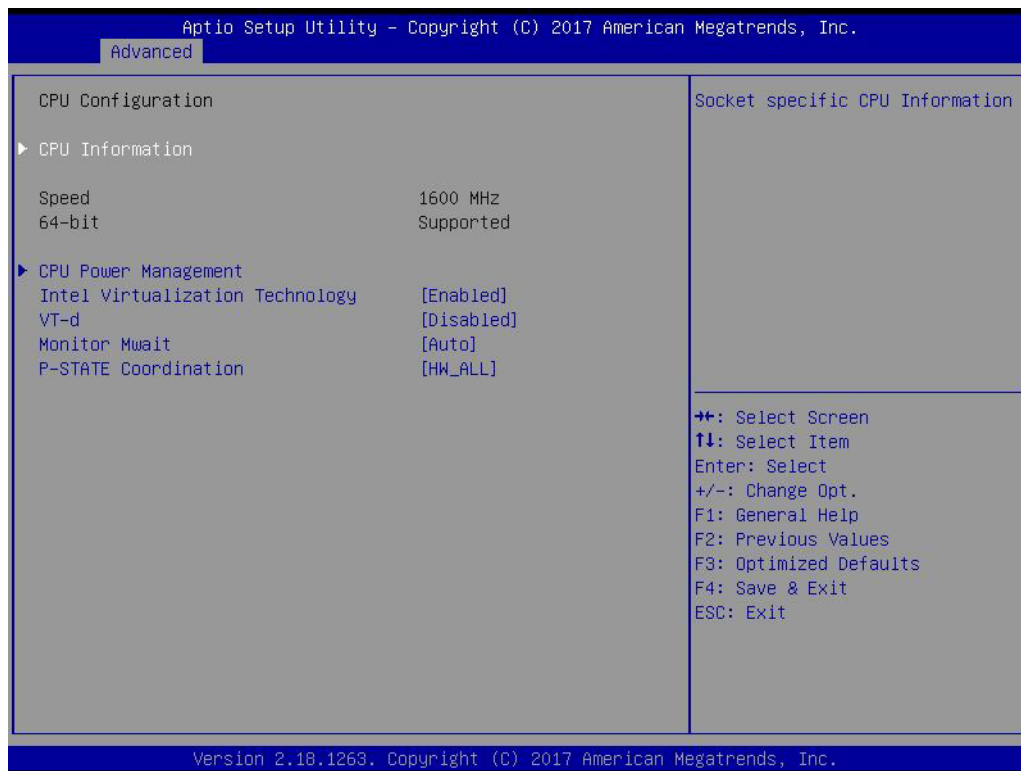

- **Intel Virtualization Technology**
When enabled, a VMM can utilize the additional hardware capabilities provided by Vanderpool Technology.
- **VT-d**
Enable/Disable CPU VT-d.
- **Monitor Mwait**
Enable/Disable Monitor Mwait.
- **P-STATE Coordination**
Change P-STATE Coordination type.

3.1.2.7 Network Stack Configuration



- **Network Stack**
Enable/Disable UEFI Network Stack.

3.1.2.8 CSM Configuration

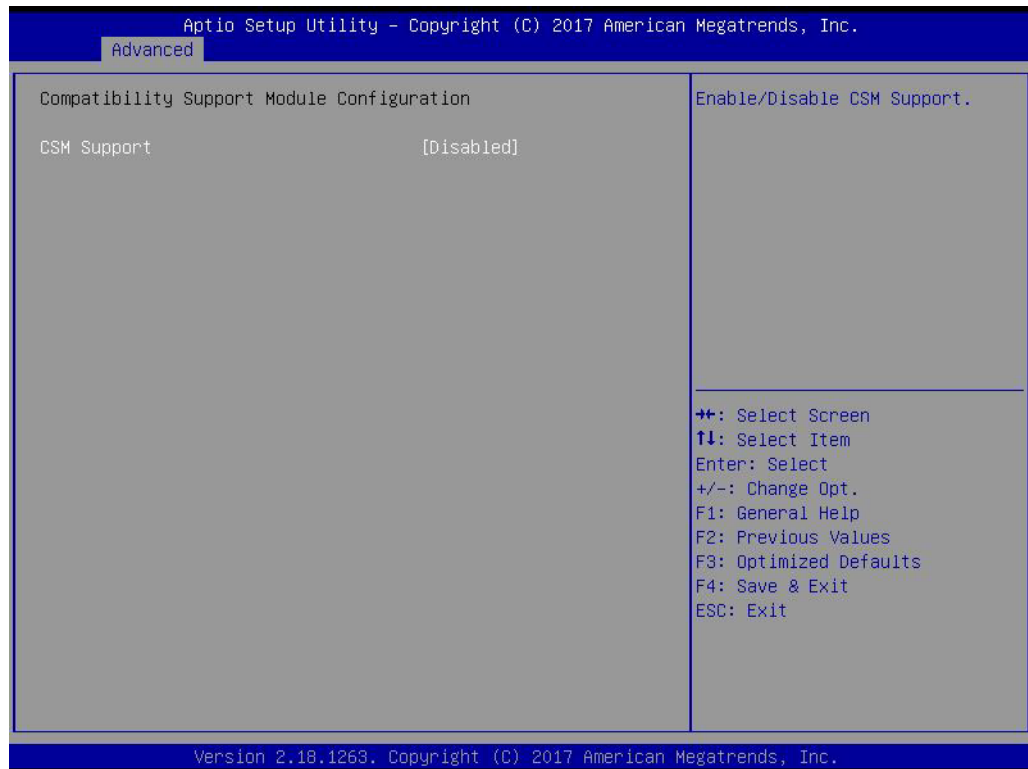

- **CSM Support**
Enable/Disable CSM Support.
- **GateA20 Active**
UPON REQUEST - GA20 can be disabled using BIOS services. ALWAYS - do not allow disabling GA20; this option is useful when any RT code is executed above 1MB.
- **Option ROM Messages**
Set display mode for Option ROM.
- **INT19 Trap Response**
BIOS reaction on INT19 trapping by Option ROM: IMMEDIATE - execute the trap right away; POSTPONED - execute the trap during legacy boot.
- **Boot option filter**
This option controls Legacy/UEFI ROMs priority.
- **Network**
Controls the execution of UEFI and Legacy PXE OpROM.
- **Storage**
Controls the execution of UEFI and Legacy Storage OpROM.
- **Video**
Controls the execution of UEFI and Legacy Video OpROM.
- **Other PCI devices**
Determines OpROM execution policy for devices other than Network, Storage, or Video.

3.1.2.9 USB Configuration

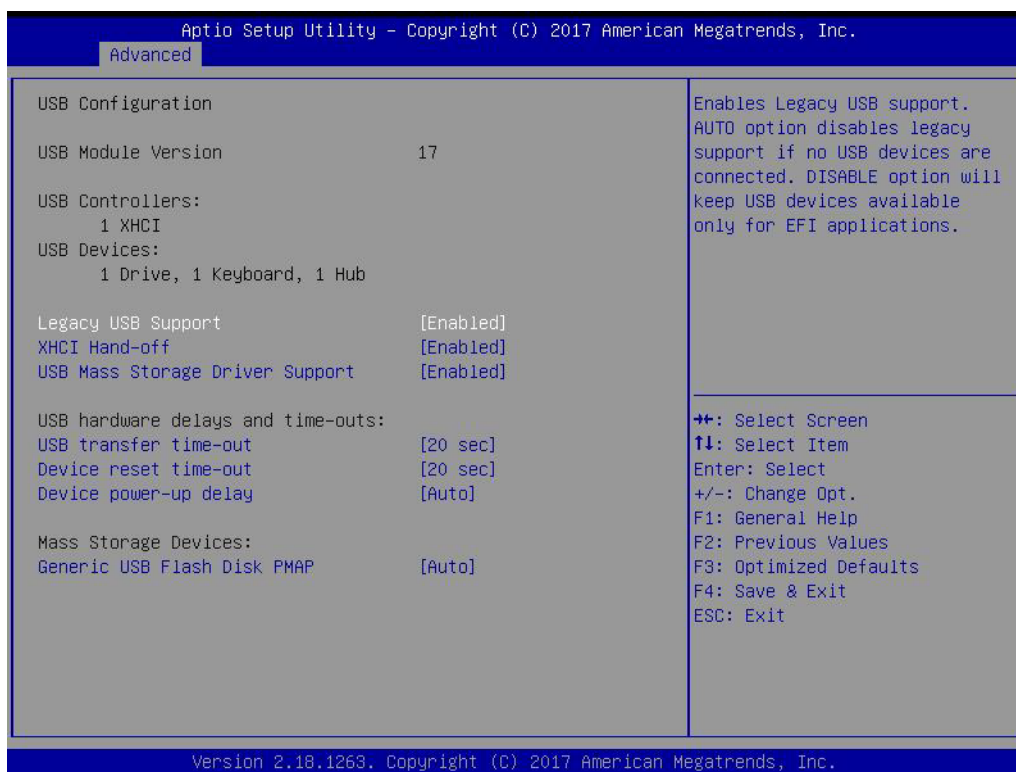

- **Legacy USB Support**
Enables Legacy USB support. AUTO option disables legacy support if no USB devices are connected. DISABLE option will keep USB devices available only for EFI applications.
- **XHCI Hand-off**
This is a workaround for OSeS without XHCI hand-off support. The XHCI ownership change should be claimed by XHCI driver.
- **EHCI Hand-Off**
This is a workaround for OSeS without EHCI hand-off support. The EHCI ownership change should claim by EHCI driver.
- **USB Mass Storage Driver Support**
Enable/Disable USB Mass Storage Driver Support.
- **Port 60/64 Emulation**
Enables I/O port 60h/64h emulation support. This should be enabled for the complete USB keyboard legacy support for non-USB aware OSeS.
- **USB transfer time-out**
Time-out value for control, Bulk, and interrupt transfers.
- **Device reset time-out**
USB mass storage device start unit command time-out.
- **Device power-up delay**
Maximum time the device will take before it properly reports itself to the Host Controller. 'Auto' uses default value: for a Root port it is 100 ms, for a Hub port the delay is taken from Hub descriptor.

3.1.2.10 Security Configuration

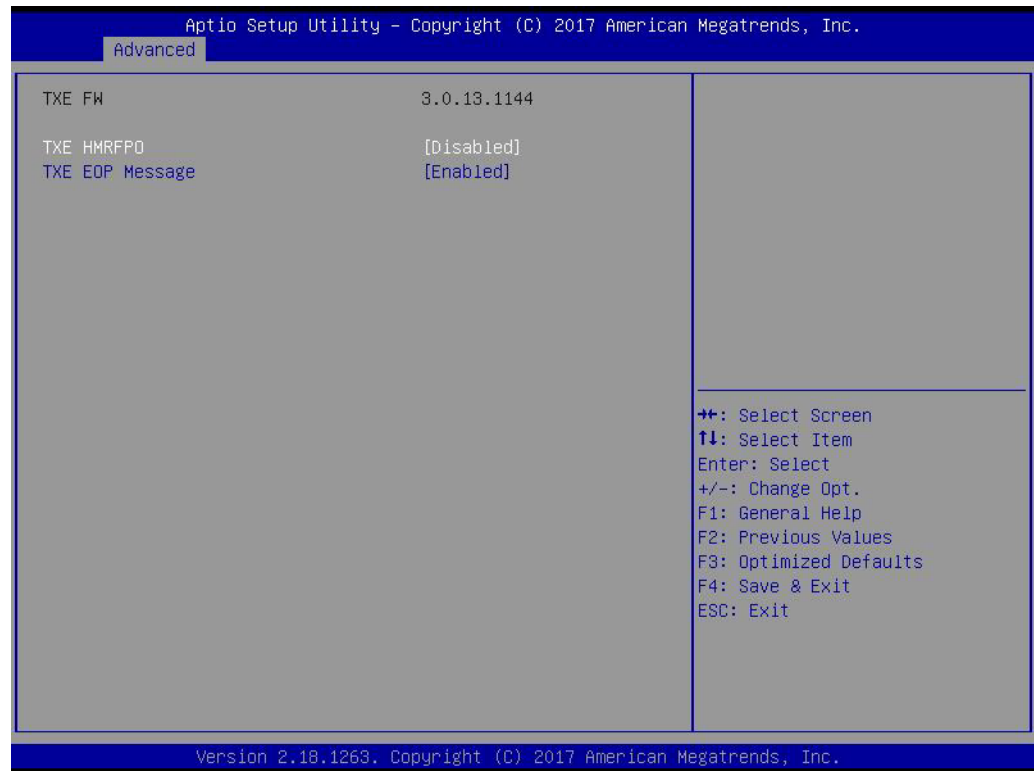

- **TXE HMRFPD Disable**
- **TXE EOP Message**
Send EOP Message Before Enter OS

3.1.2.11 IT8768E Super I/O Configuration

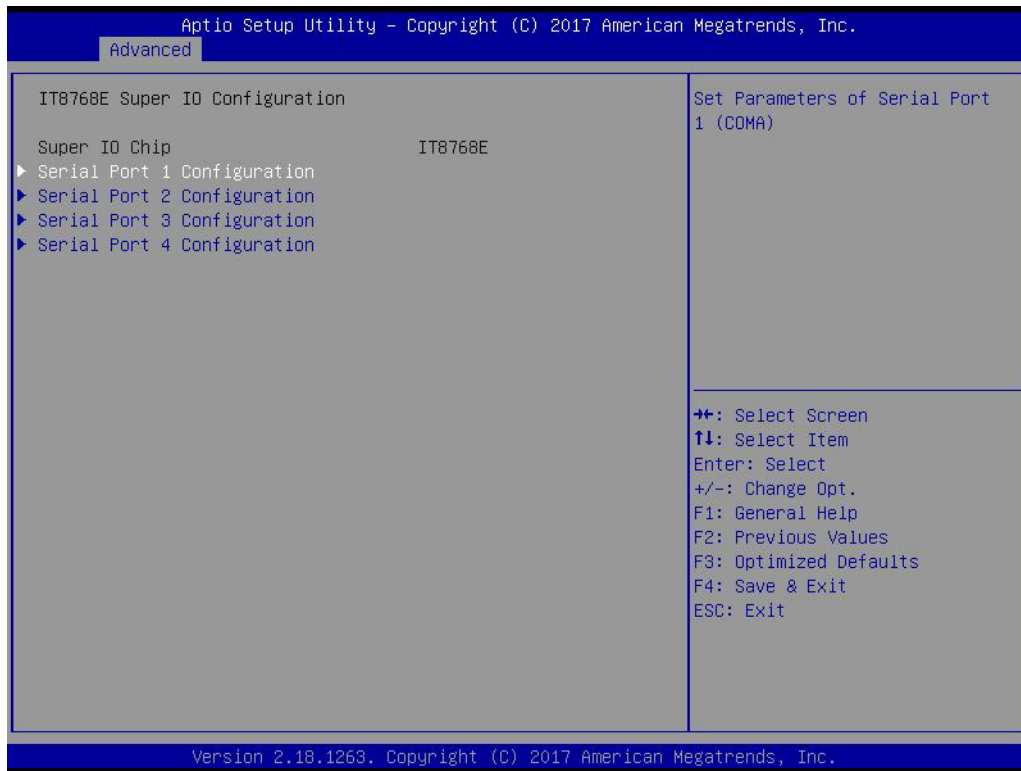

- **Serial Port 1 Configuration**
Set Parameters of Serial Port 1 (COMA).
- **Serial Port 2 Configuration**
Set Parameters of Serial Port 2 (COMB).
- **Serial Port 3 Configuration**
Set Parameters of Serial Port 3 (COMC).
- **Serial Port 4 Configuration**
Set Parameters of Serial Port 4 (COMD).

3.1.3 Chipset Configuration

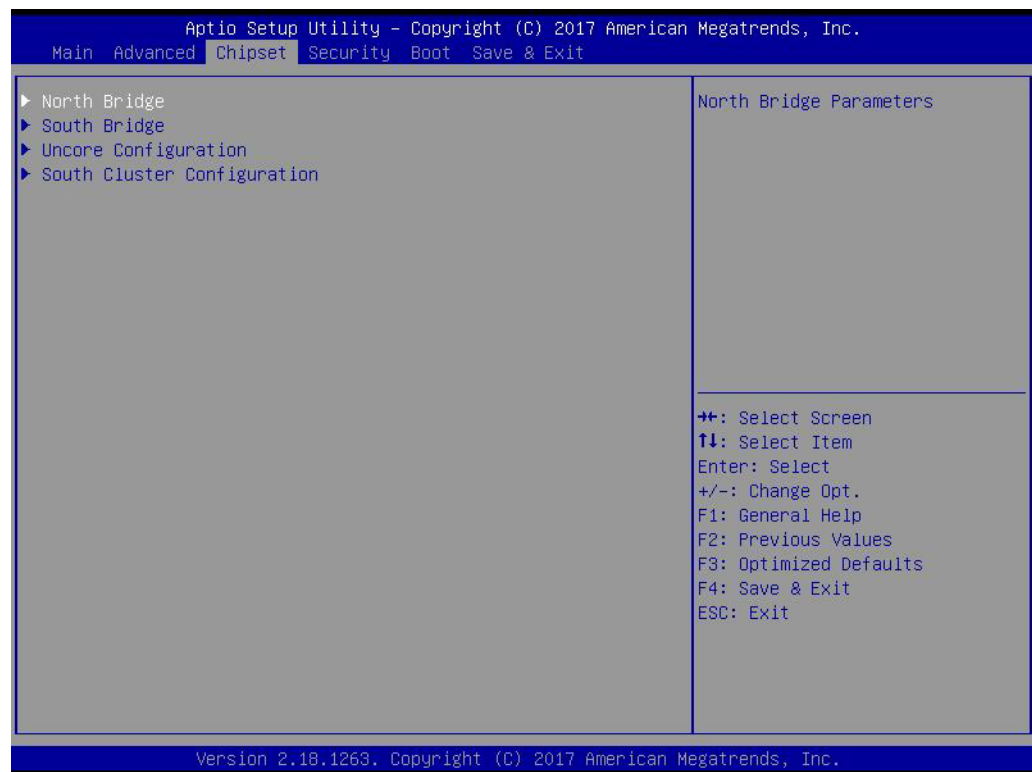

- **North Bridge**
Details for North Bridge items.
- **South Bridge**
Details for South Bridge items.
- **Uncore Configuration**
Details for Uncore Configuration.
- **South Cluster Configuration**
Details for South Cluster Configuration.

3.1.3.1 North Bridge

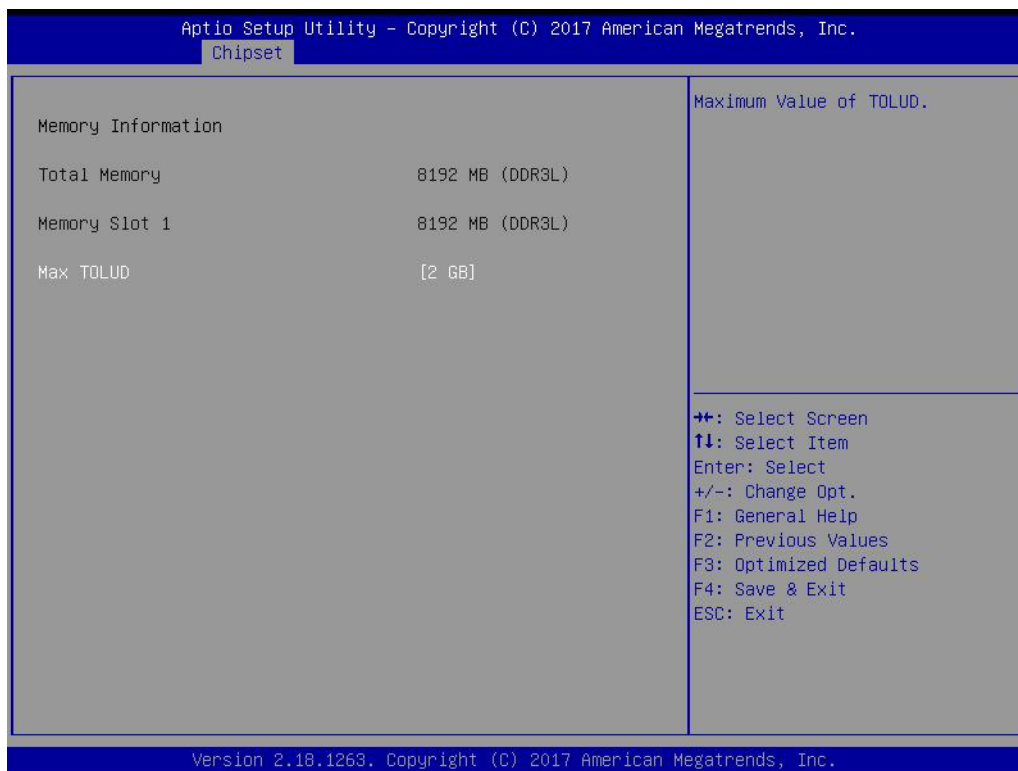

- **Max TOLUD**
Maximum Value of TOLUD.

3.1.3.2 South Bridge

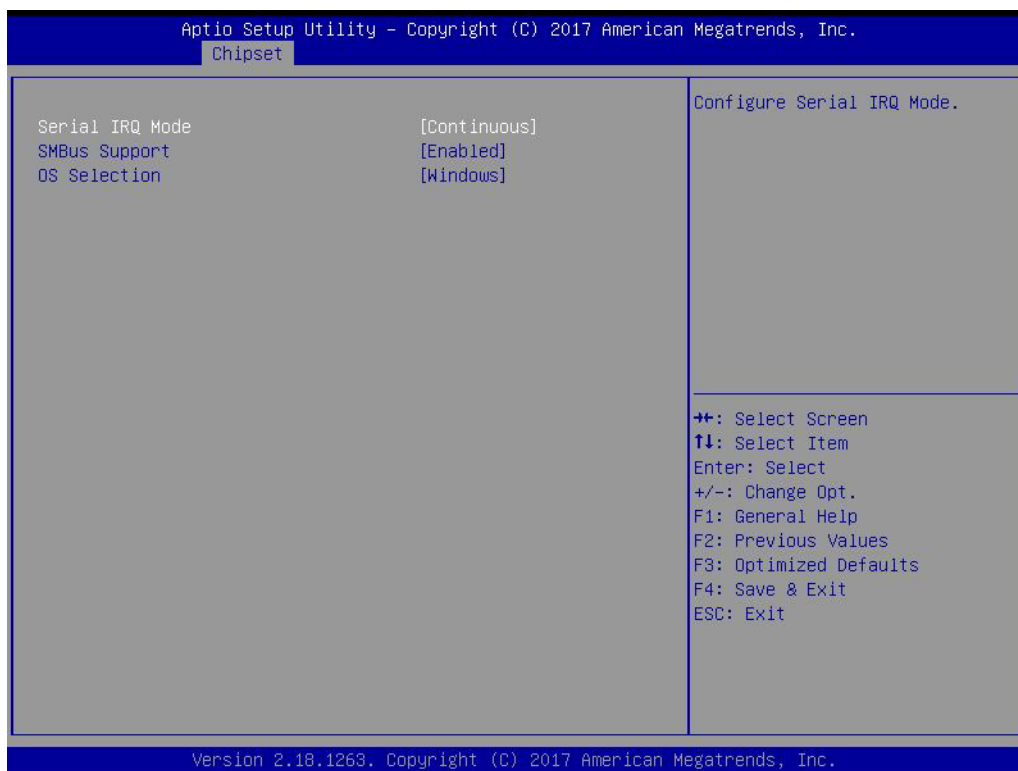

- **Serial IRQ Mode**
Configure Serial IRQ Mode.
- **SMBus Support**
Enable/Disable SMBus Support.
- **OS Selection**
Select the target OS.

3.1.3.3 Uncore Configuration

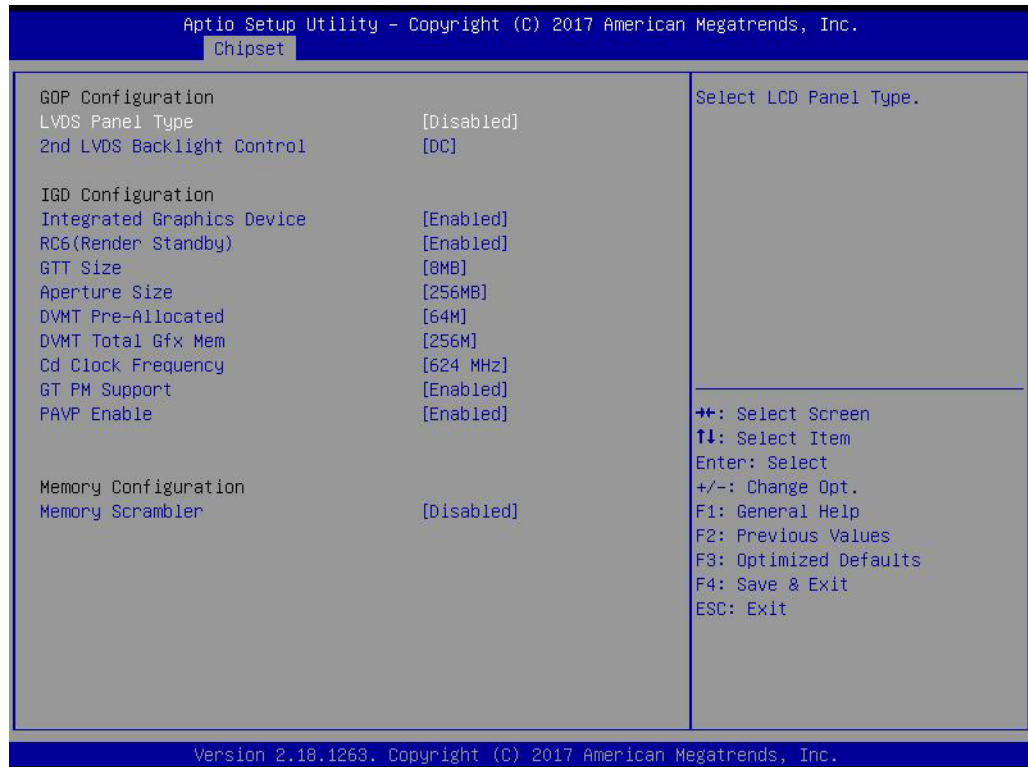

- **LVDS Panel Type**
Select LCD Panel Type.
- **2nd LVDS Backlight Control**
Switch Backlight Control for PWM or DC mode. (For MIOe Module).
- **Integrated Graphics Device**
Enable: Enable Integrated Graphics Device (IGD) when selected as the Primary Video Adaptor. Disable: Always disable IGD.
- **RC6 Render Standby)**
Check to enable render standby support.
- **GTT Size**
Select the GTT Size
- **Aperture Size**
Select the Aperture Size.
- **DVMT Pre-Allocated**
Select DVMT 5.0 Pre-Allocated (Fixed) Graphics Memory size used by the Internal Graphics Device.
- **DVMT Total Gfx Mem**
Select DVMT 5.0 Total Graphic Memory size used by the Internal Graphics Device.

- **Cd Clock Frequency**
Select the highest Cd Clock frequency supported by the platform.
- **GT PM Support**
Enable/Disable GT PM Support.
- **PAVP Enable**
Enable/Disable PAVP.
- **Memory Scrambler**
Enable/Disable Memory Scrambler support.

3.1.3.4 South Cluster Configuration

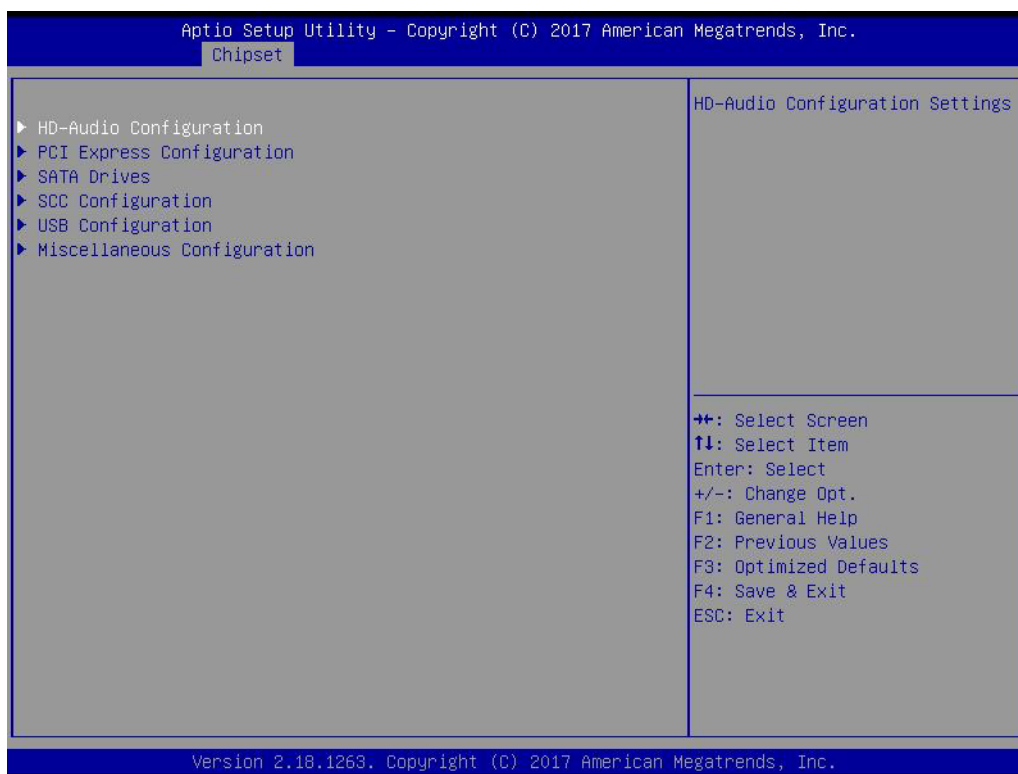

- **HD-Audio Configuration**
HD-Audio Configuration Settings.
- **PCI Express Configuration**
PCI Express Configuration Settings.
- **SATA Drives**
Press <Enter> to select the SATA Device Configuration Setup options.
- **SCC Configuration**
SCC Configuration Settings.
- **USB Configuration**
USB Configuration Settings.
- **Miscellaneous Configuration**
Enable/Disable Misc. Features.

■ HD-Audio Configuration

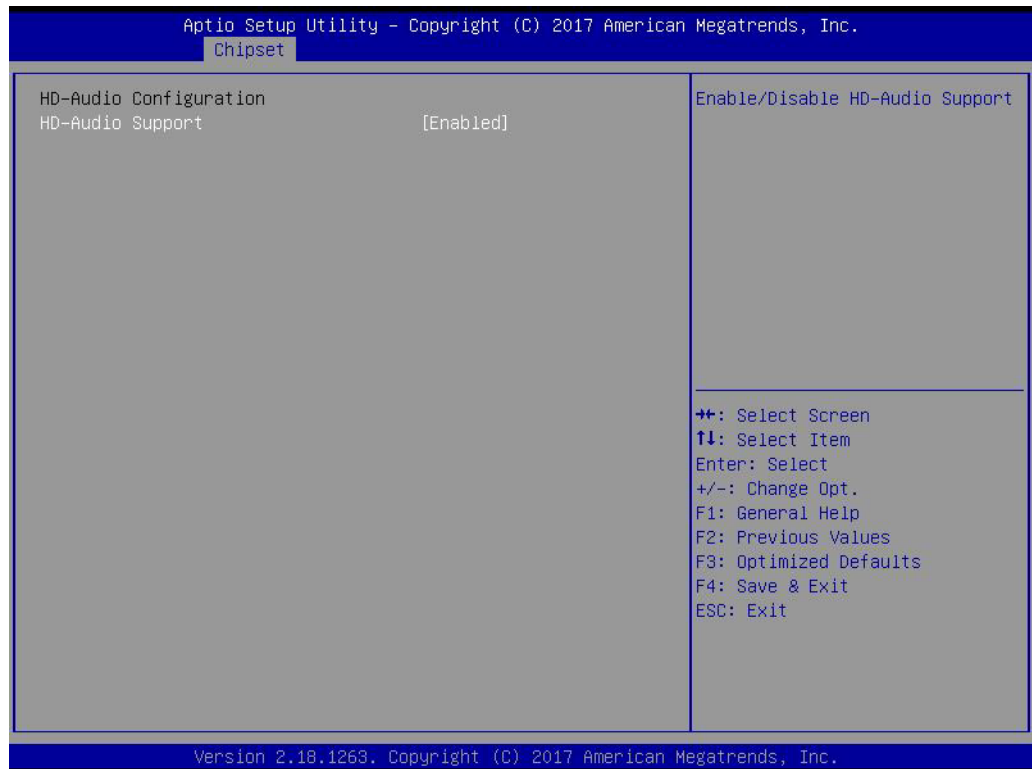

- HD-Audio Support
Enable/Disable HD-Audio Support.

■ PCI Express Configuration

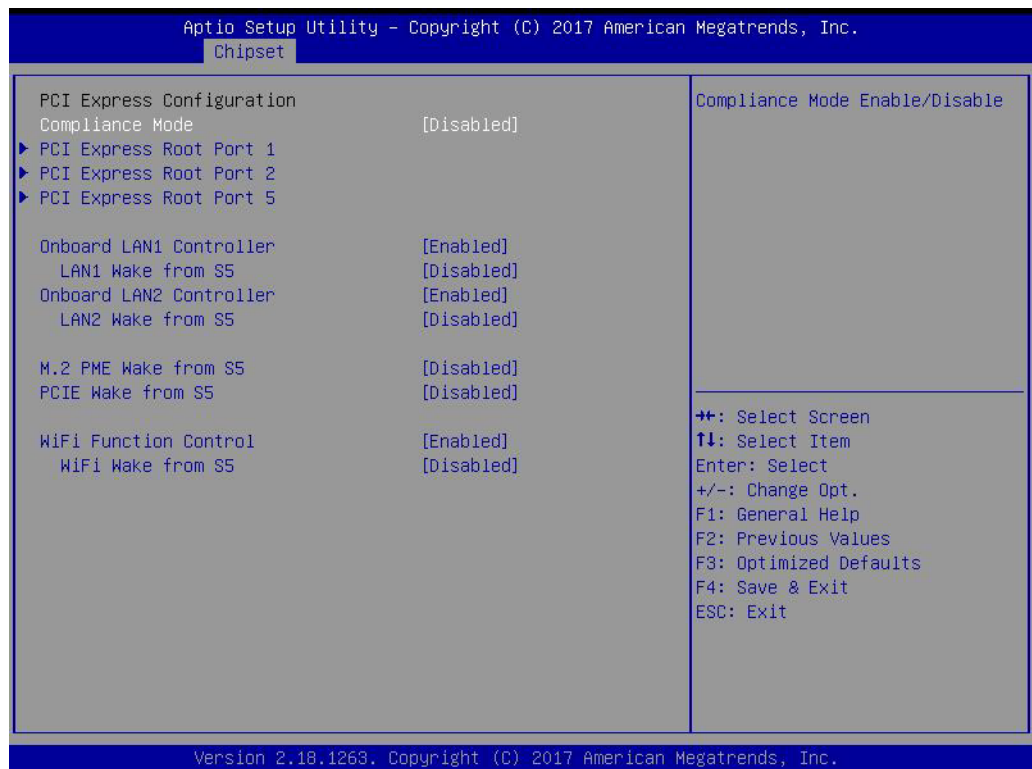

- Compliance Mode
Compliance Mode Enable/Disable.

- PCI Express Root Port 1 / 2 / 5
Control the PCI Express Root Port.
- Onboard LAN1/LAN2 Controller
Select to Enable or Disable Onboard LAN1/LAN2 Controller.
- LAN Option ROM
Enabled / Disabled Onboard LAN's PXE option ROM.
- M.2 PME Wake from S5
Enable or Disable M.2 PME to wake the system from S5.
- PCIE Wake
Enable or disable PCIE to wake the system from S5.
- WiFi Function Control
Enable or Disable WiFi function.
- WiFi Wake from S5
Enable or Disable WiFi wake up the system from S5.

■ SATA Drives

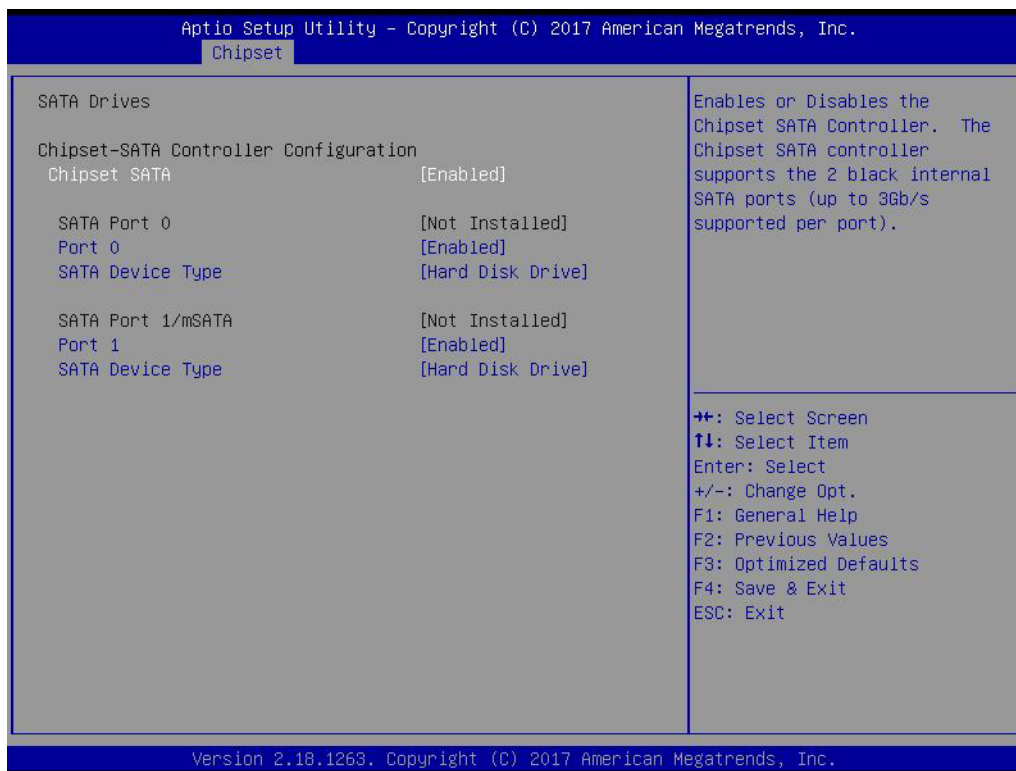

- Chipset SATA
Enable or Disable the Chipset SATA Controller.

■ SCC Configuration

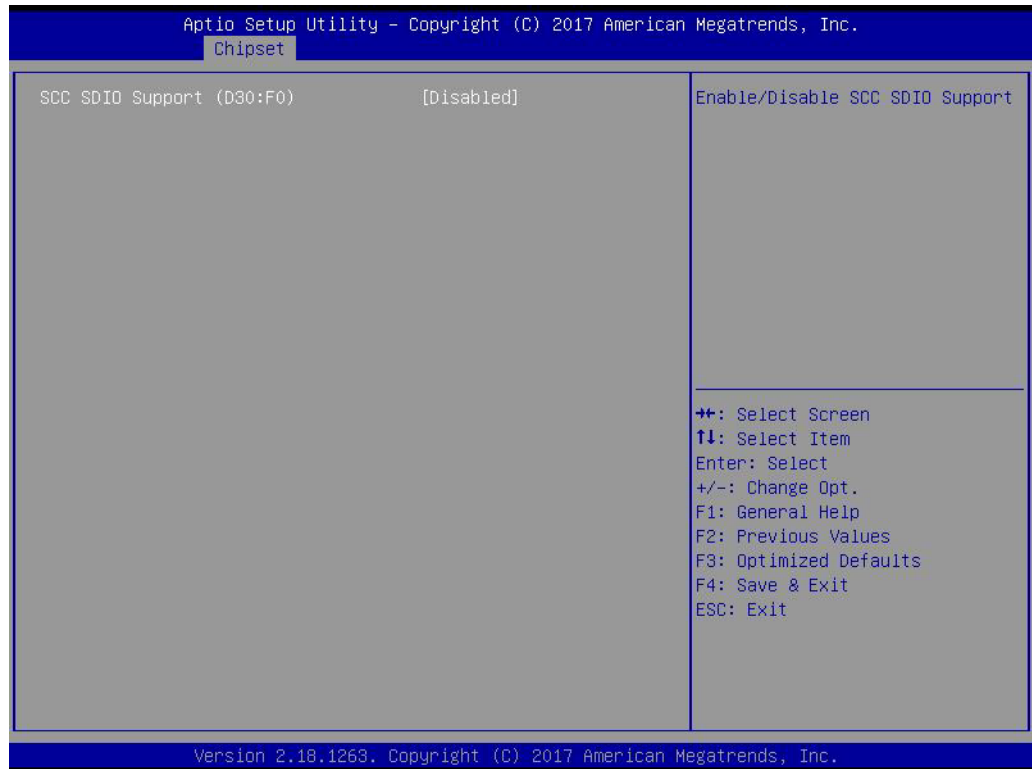

- SCC SDIO Support (D30:F0)
Enable/Disable SCC SDIO Support.

■ USB Configuration

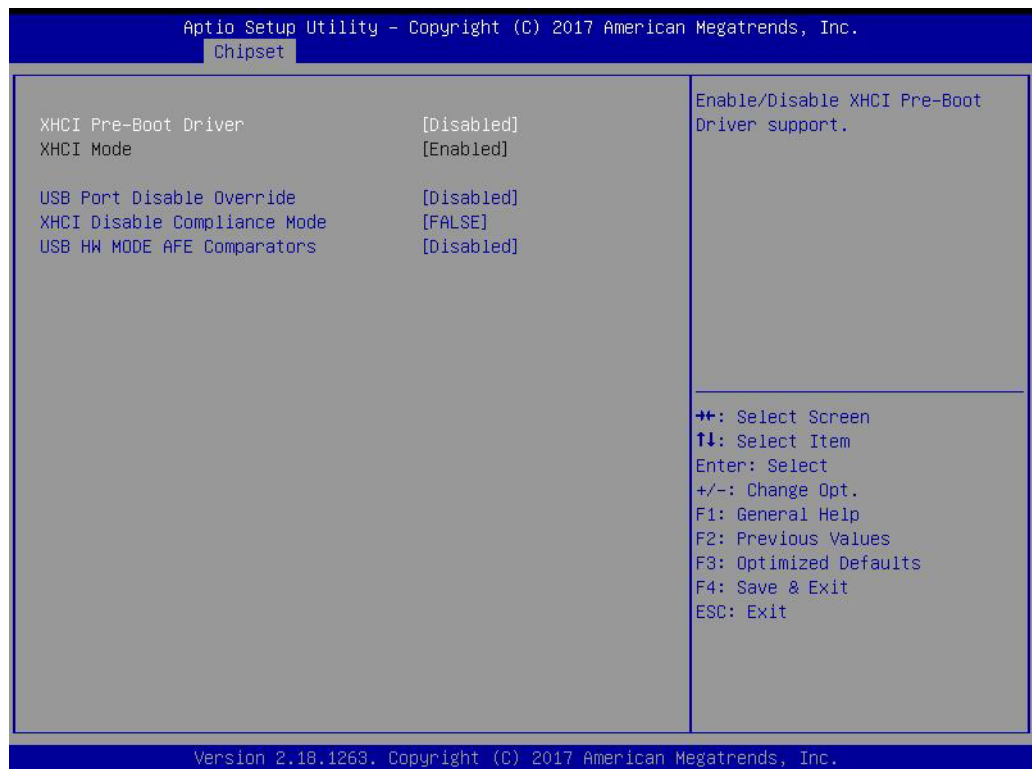

- XHCI Pre-Boot Driver
Enable/Disable XHCI Pre-Boot Driver Support.

- USB Port Disable Override
Selectively Enable/Disable corresponding USB port from reporting a Device Connection to the controller.
- XHCI Disable Compliance Mode
Options to disable XHCI Link Compliance Mode.
- USB HW MODE AFE Comparators
Enable/Disable USB HW MODE AFE Comparators.

■ Miscellaneous Configuration

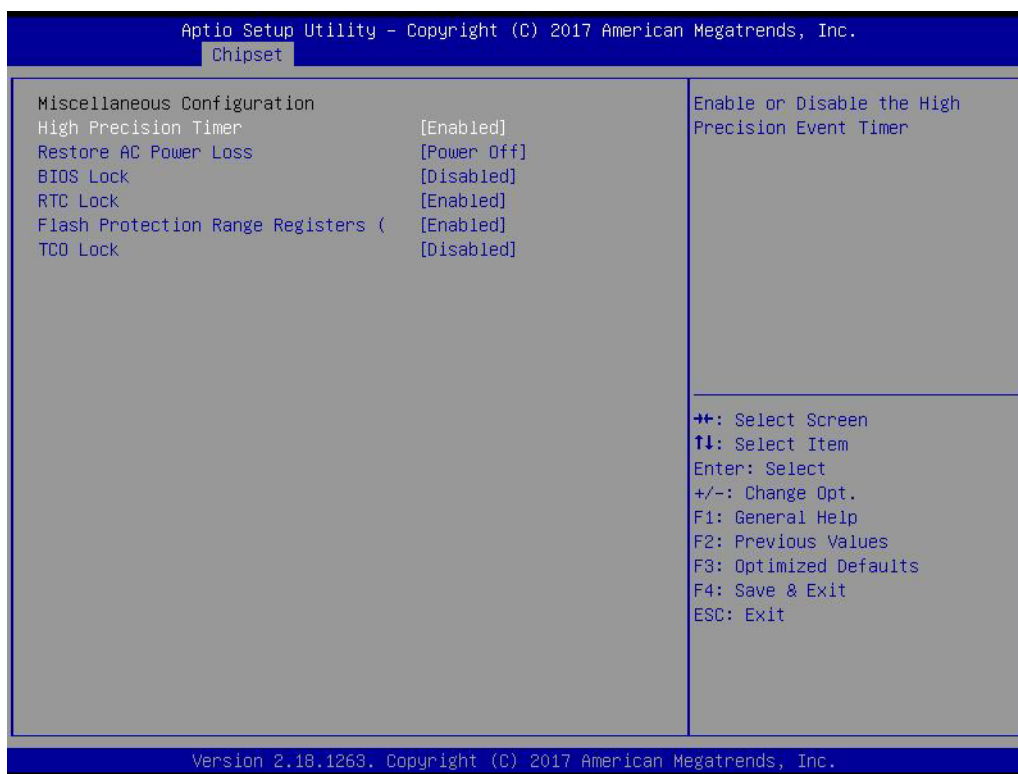

- High Precision Timer
Enable or Disable the High Precision Timer.
- Restore AC Power Loss
Specify what state to go to when power is re-applied after a power failure (G3 state).
- BIOS Lock
Enable/Disable the BIOS Lock Enable feature.
- RTC Lock
Enable or disable bytes 38h-3Fh in the upper and lower 128-byte bank of RTC RAM lockdown.
- Flash Protection Range Registers
Enable/Disable the SC BIOS Lock Enable feature.
- TCO SMI Lock
Enable TCO and Lock Down TCO.

3.1.4 Security

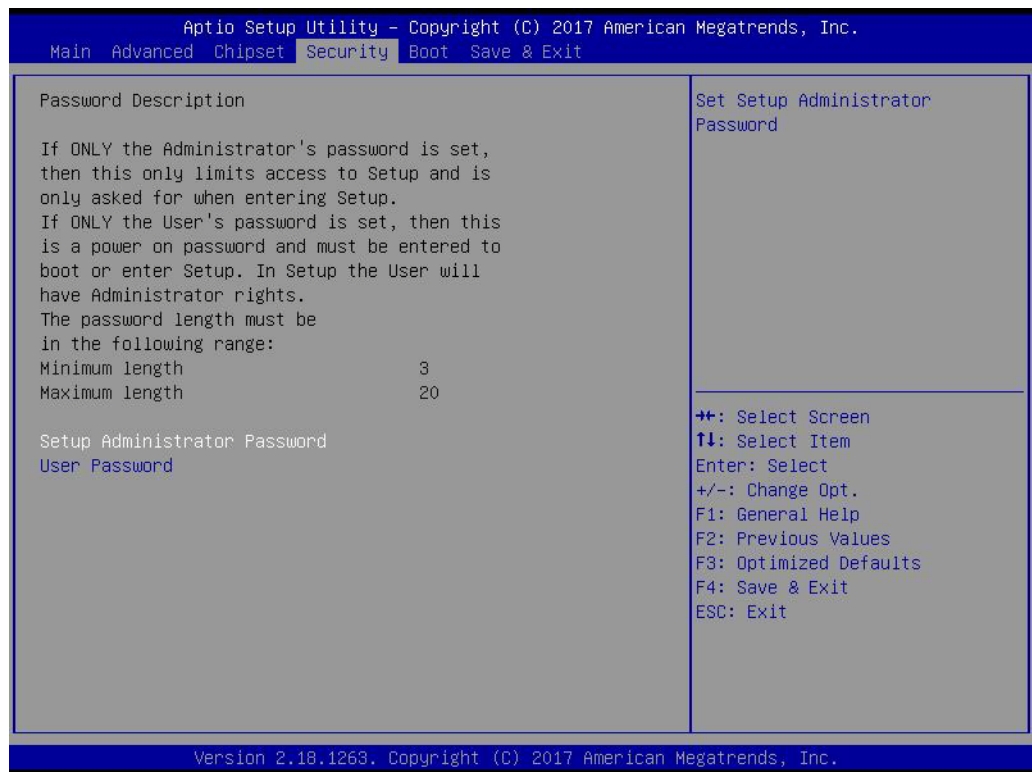

Select Security Setup from the MIO-5350 Setup main BIOS setup menu. All Security Setup options, such as password protection and virus protection are described in this section. To access the sub menu for the following items, select the item and press <Enter>:

- **Change Administrator / User Password**
Select this option and press <ENTER> to access the sub menu, and then type in the password.

3.1.5 Boot

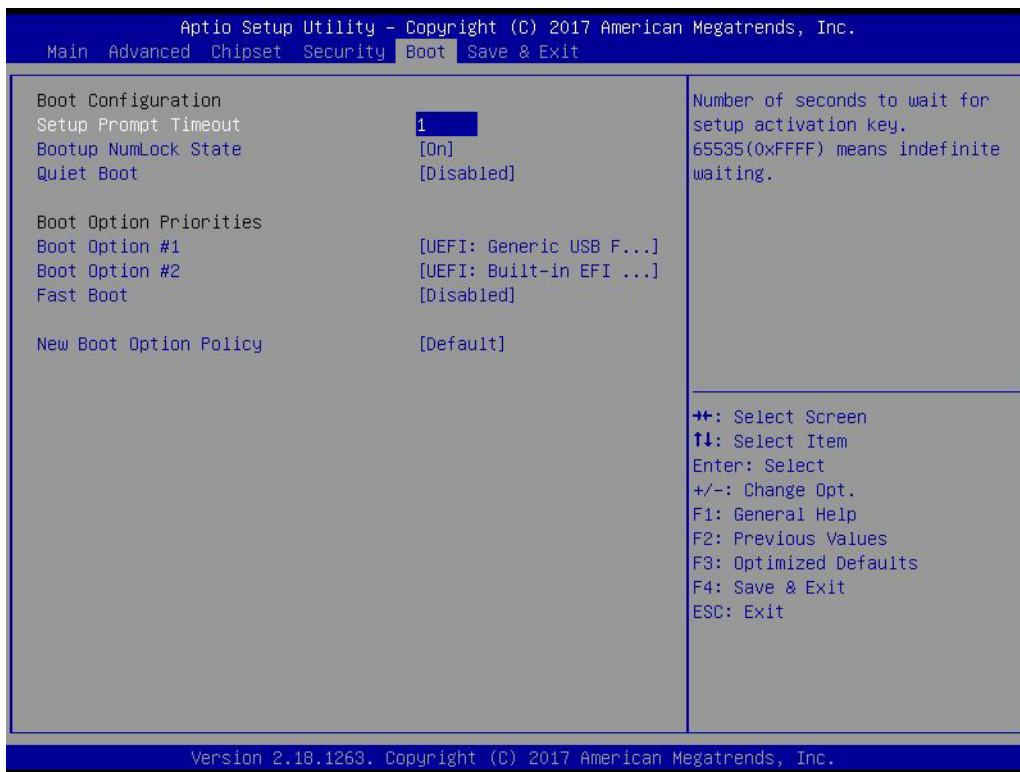

- **Setup Prompt Timeout**
Number of seconds that the firmware will wait before initiating the original default boot selection. A value of 0 indicates that the default boot selection is to be initiated immediately on boot. A value of 65535(0xFFFF) indicates that firmware will wait for user input before booting. This means the default boot selection is not automatically started by the firmware.
- **Bootup NumLock State**
Select the keyboard NumLock state.
- **Quiet Boot**
Enables or disables Quiet Boot option.
- **Boot Option #1**
Sets the system boot order.
- **Fast Boot**
Enables or disables boot with initialization of a minimal set of devices required to launch active boot option. Has no effect for BBS boot options.
- **New Boot Option Policy**
Controls the placement of newly detected UEFI boot options.

3.1.6 Save & Exit

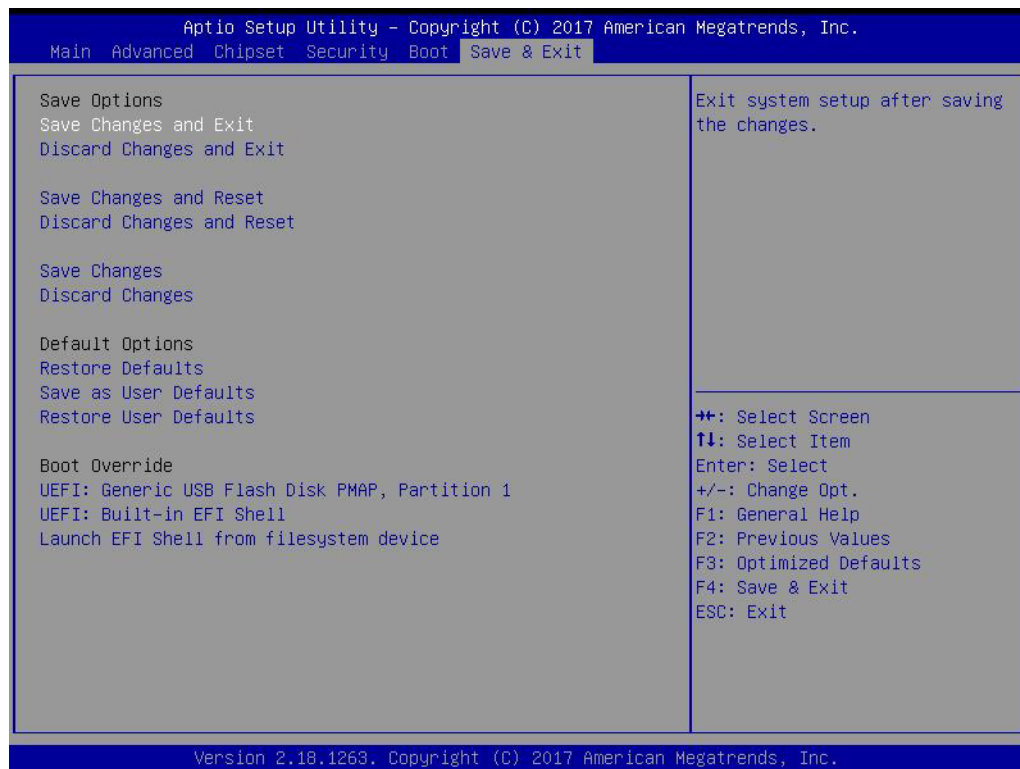

- **Save Changes and Exit**
This item allows you to exit system setup after saving the changes.
- **Discard Changes and Exit**
This item allows you to exit system setup without saving any changes.
- **Save Changes and Reset**
This item allows you to reset the system after saving the changes.
- **Discard Changes and Reset**
This item allows you to rest system setup without saving any changes.
- **Save Changes**
This item allows you to save changes done so far to any of the options.
- **Discard Changes**
This item allows you to discard changes done so far to any of the options.
- **Restore Defaults**
This item allows you to restore/load default values for all the options.
- **Save as User Defaults**
This item allows you to save the changes done so far as user defaults.
- **Restore User Defaults**
This item allows you to restore the user defaults to all the options.
- **Boot Override**
Boot device select can override your boot priority.

Chapter 4

MIOe Installation

The MI/O compact form factor SBC is a new-generation SBC design with a variety of mechanical improvements. Here is the quick installation guide for our thermal design and MIOe module installation.

4.1 Quick Installation Guide:

1. There is a Heatsink / Cooler in the white box inside the package. Carefully remove the release paper from the thermal pad before installation.

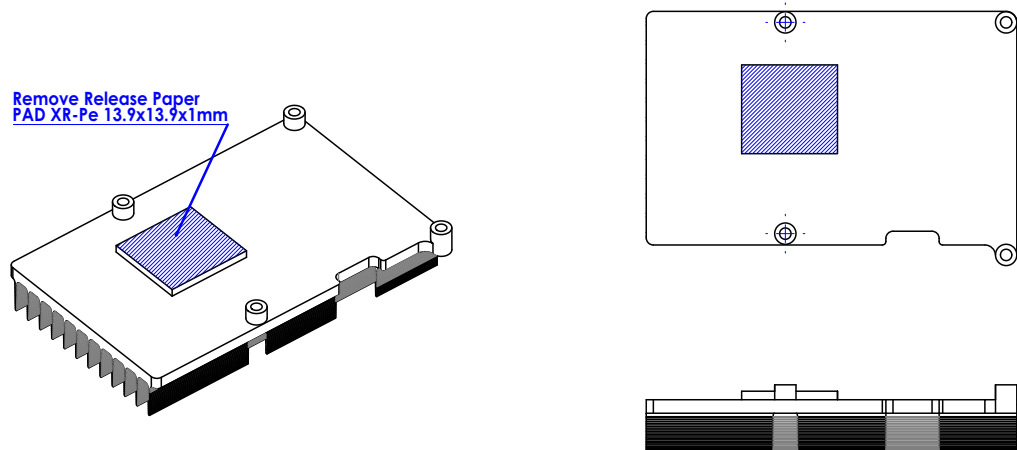

2. There are six screws and six studs inside the white box, please install the heat-sink in place as per illustration below:

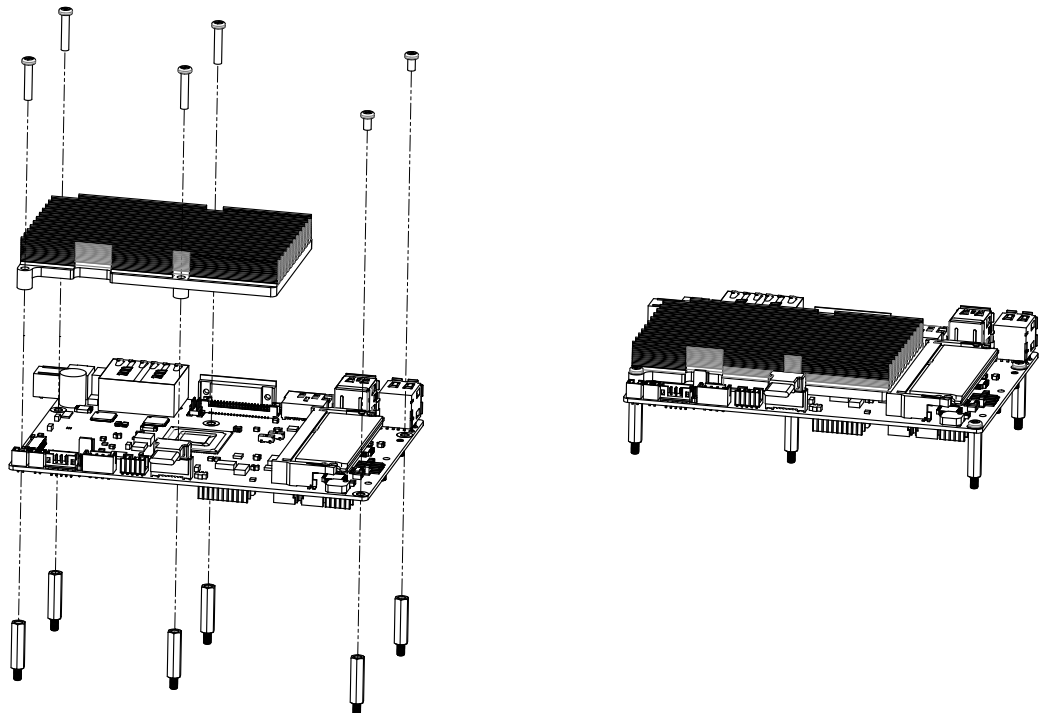

Appendix **A**

Pin Assignments

This appendix contains information of a detailed or specialized nature.

Sections include:

- Jumper and Connector Tables

A.1 Jumper List

J1	Clear CMOS
Part Number	1653003101
Footprint	HD_3x1P_79_D
Description	PIN HEADER 3x1P 2.0mm 180D(M) DIP 2000-13 WS
Setting	Function
(1-2)*	Normal
(2-3)	Clear COMS



J2	Auto Power On Setting
Part Number	1653002101-02
Footprint	HD_2x1P_79_D
Description	
Setting	Function
NC	Power Button for Power On
(1-2)*	Auto Power On

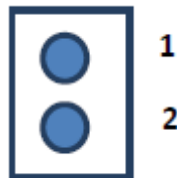

J3	LCD Power
Part Number	1653003260
Footprint	HD_3x2P_79
Description	PIN HEADER 3x2P 2.0mm 180D(M) SMD 21N22050
Setting	Function
(1-3)*	+3.3V
(3-5)	+5V
(3-4)	+12V

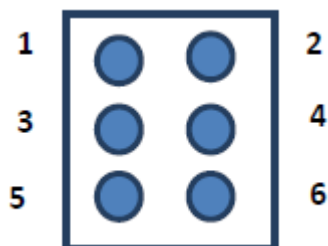

J4	LVDS VCON Setting
Part Number	1653000014
Footprint	HD_2x2P_79
Description	PIN HEADER 2x2P 2.00mm 180D(M) SMD 21N22050
Setting	Function
(1-2)*	3.3V High for VCON on LVDS
(1-3)	Low for VCON on LVDS



A.2 Connectors

Table A.1: Connectors

Label	Function
CN1	12V Power Input
CN3	Battery
CN4	SODIMMDDR3_204
CN5	Power Switch
CN7	Reset
CN8	GPIO
CN9	eDP
CN10	DP/HDMI
CN11	VGA
CN12	Inverter Power Output
CN13	48-bit LVDS Panel
CN15	LAN
CN17	Audio
CN18	SATA
CN19	SATA Power
CN20	mSATA
CN22	M.2 E Key
CN23	COM1/COM2
CN24	COM3/COM4/RS422/RS485
CN25	External USB3.0
CN26	External USB2.0
CN27	Internal USB
CN28	MIOe3.0
CN29	+12V FAN
CN30	SMBus
CN31	SATA

CN1	12V Power Input
Part Number	1655003865
Footprint	WF_2x2P_165_BOX_RA_D_740SP
Description	ATX PWRCONN 2x2P 4.2mm 90D(M) DIP 740-77-04TS50
Pin	Pin Name
1	GND
2	GND
3	+12V
4	+12V

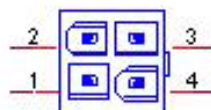

CN3	Battery
Part Number	1655005427-01
Footprint	WF_2P_49_53398-0271
Description	
Pin	Pin Name
1	GND
2	+3V

CN4	SODIMMDDR3_204
Part Number	1651002088
Footprint	SODIMMDDR3_204P_AS0A626-HA
Description	DDR3 SODIMM H=9.2mm 204P SMD AS0A626-HASN-7H
Pin	Pin Name

CN5	Power Switch
Part Number	1655302020
Footprint	WF_2P_79_BOX_R1_D
Description	WAFER BOX 2P 2.0mm 180D(M) DIP A2001WV2-2P
Pin	Pin Name
1	PSIN
2	GND



CN7	Reset
Part Number	1655302020
Footprint	WF_2P_79_BOX_R1_D
Description	WAFER BOX 2P 2.0mm 180D(M) DIP A2001WV2-2P
Pin	Pin Name
1	RESET#
2	GND

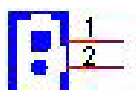

CN8	GPIO
Part Number	1653004099
Footprint	HD_5x2P_79_23N685B-10M10
Description	BOX HEADER 5x2P 2.00mm 180D(M) SMD 23N685B-10M10
Pin	Pin Name
1	+5V
2	GPIO4
3	GPIO0
4	GPIO5
5	GPIO1
6	GPIO6
7	GPIO2
8	GPIO7
9	GPIO3
10	GND

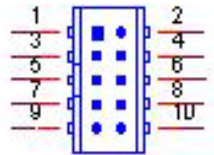

CN9	eDP
Part Number	1653006914-01
Footprint	df13-20dp-125v
Description	WTB 2x10P 1.25mm 180D(M) SMD W/P DF13E-20DP-1.25
Pin	Pin Name
1	GND
2	GND
3	eDP_TX0-
4	eDP_TX3-
5	eDP_TX0+
6	eDP_TX3+
7	GND
8	NC
9	eDP_TX1-
10	NC
11	eDP_TX1+
12	eDP_AUX-
13	GND
14	eDP_AUX+
15	eDP_TX2-
16	GND
17	eDP_TX2+
18	eDP_HPD
19	+12V or +5V or +3.3V

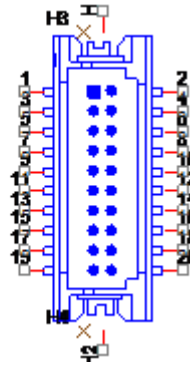

CN10	DP/HDMI
Part Number	1654010203
Footprint	HDMICON_21P_845-002-217CRL
Description	HDMI+DISPLAY Conn. 20P 90D(M) DIP 845-002-217CRL
Pin	Pin Name
1	ML_Lane0(p)/TMDS Data2+
2	GND/TMDS Data2 Shield
3	ML_Lane0(n)/TMDS Data2-
4	ML_Lane1(p)/TMDS Data1+
5	GND/TMDS Data1 Shield
6	ML_Lane1(n)/TMDS Data1-
7	ML_Lane2(p)/TMDS Data0+
8	GND/TMDS Data0 Shield
9	ML_Lane2(n)/TMDS Data0-
10	ML_Lane3(p)/TMDS Clock+
11	GND/TMDS Clock Shield
12	ML_Lane3(n)/TMDS Clock-
13	CONFIG1/Reserved
14	CONFIG2/Reserved
15	AUX CH(p)/SCL
16	GND/SDA
17	AUX CH(n)/DDC Ground
18	Hot Plug Detect/+5V Power
19	GND/Hot Plug Detect
20	+3.3V

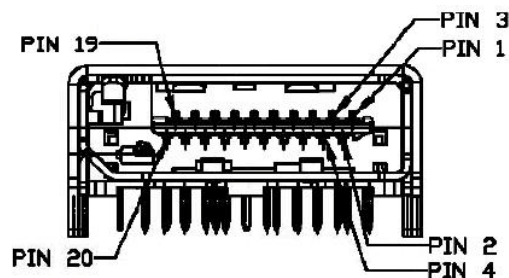

CN11	VGA
Part Number	1654011261-01
Footprint	DBVGA-VF5MS
Description	
Pin	Pin Name
1	RED
2	GREEN
3	BLUE
4	NC
5	GND
6	GND
7	GND
8	GND
9	NC
10	GND
11	NC
12	DDAT
13	HSYNC
14	VSYNC
15	DCLK

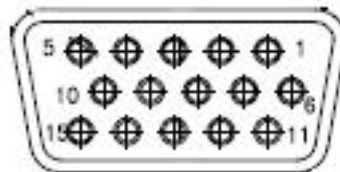

CN12	Inverter Power Output
Part Number	1655000453
Footprint	WHL5V-2M-24W1140
Description	
WAFER BOX 2.0mm 5P 180D(M) DIP WO/Pb JIH VEI	
Pin	Pin Name
1	+12V
2	GND
3	ENABKL
4	VBR
5	+5V

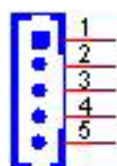

CN13	48-bit LVDS Panel
Part Number	1653920200
Footprint	SPH20X2
Description	B/B Conn. 40P 1.25mm 90D SMD DF13-40DP-1.25V(91)
Pin	Pin Name
1	+12V or +5V or +3.3V
2	+12V or +5V or +3.3V
3	GND
4	GND
5	+5V or +3.3V
6	+5V or +3.3V
7	LVDS0_D0-
8	LVDS1_D0-
9	LVDS0_D0+
10	LVDS1_D0+
11	GND
12	GND
13	LVDS0_D1-
14	LVDS1_D1-
15	LVDS0_D1+
16	LVDS1_D1+
17	GND
18	GND
19	LVDS0_D2-
20	LVDS1_D2-
21	LVDS0_D2+
22	LVDS1_D2+
23	GND
24	GND
25	LVDS0_CLK-
26	LVDS1_CLK-
27	LVDS0_CLK+
28	LVDS1_CLK+
29	GND
30	GND
31	NC
32	NC
33	GND
34	GND
35	LVDS0_D3-
36	LVDS1_D3-
37	LVDS0_D3+
38	LVDS1_D3+
39	NC
40	NC

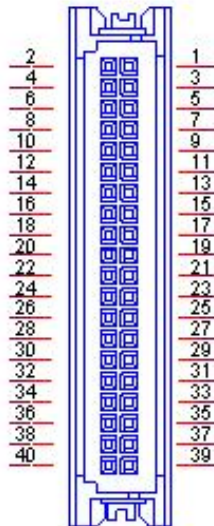

CN15		LAN	
Part Number	1652003274		
Footprint	RJ45_28P_RTB-19GB9J1A		
Description	PHONE JACK RJ45 28P DIP RTB-19GB9J1A		
Pin	Pin Name		
1	TX+(10/100),BI_DA+(GHz)		
2	TX-(10/100),BI_DA-(GHz)		
3	RX+(10/100),BI_DB+(GHz)		
4	BI_DC+(GHz)		
5	BI_DC-(GHz)		
6	RX-(10/100),BI_DB-(GHz)		
7	BI_DD+(GHz)		
8	BI_DD-(GHz)		

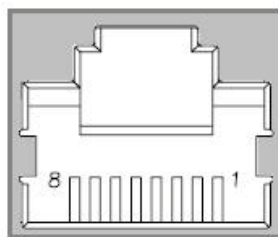

CN17	Audio
Part Number	1653004099
Footprint	HD_5x2P_79_23N685B-10M10
Description	BOX HEADER 5x2P 2.00mm 180D(M) SMD 23N685B-10M10
Pin	Pin Name
1	LOUTR
2	LINR
3	GND
4	GND
5	LOUTL
6	LINL
7	GND
8	GND
9	MIC1R
10	MIC1L

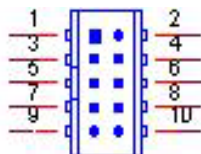

Matching Cable: 1703100152

CN18	SATA
Part Number	1654011616-01
Footprint	SATA_7P_WATF-07DBN6SB1U
Description	
Pin	Pin Name
1	GND
2	TX+
3	TX-
4	GND
5	RX-
6	RX+
7	GND

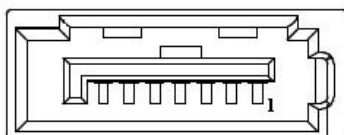

CN19	SATA Power
Part Number	1655001154
Footprint	WF_4P_98_BOX_R1_D
Description	WAFER BOX 4P 2.50mm 180D(M) DIP 24W1170-04S10-01
Pin	Pin Name
1	+5V
2	GND
3	GND
4	+12V

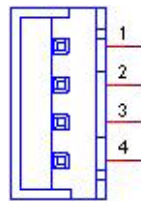

CN20	mSATA
Part Number	00A00000770
Footprint	MINIPCIE_HALF_PICO_ITX
Description	
Pin	Pin Name
1	WAKE#
2	+3.3V
3	NC
4	GND
5	NC
6	+1.5V
7	NC
8	NC
9	GND
10	NC
11	NC
12	NC
13	NC
14	NC
15	GND
16	NC
17	NC
18	GND
19	NC
20	W_DISABLE#
21	GND
22	PERST#
23	SATA_RX+
24	+3.3V

25	SATA_RX-
26	GND
27	GND
28	+1.5V
29	GND
30	SMB_CLK
31	SATA_TX-
32	SMB_DAT
33	SATA_TX+
34	GND
35	GND
36	USB D-
37	GND
38	USB D+
39	+3.3V
40	GND
41	+3.3V
42	NC
43	GND
44	NC
45	NC
46	NC
47	NC
48	+1.5V
49	NC
50	GND
51	NC
52	+3.3V

CN22		M.2 E Key
Part Number	1654011871-01	
Footprint	NGFF_75P_2199230-2	
Description		
Pin	Pin Name	
1	GND	
2	+3.3VSB	
3	USB_D+	
4	+3.3VSB	
5	USB_D-	
7	GND	
9	SDIO_CLK	
11	SDIO_CMD	
13	SDIO_DATA0	
15	SDIO_DATA1	
17	SDIO_DATA2	
18	GND	
19	SDIO_DATA3	

21	SDIO_WAKE#
23	SDIO_RESET#
33	GND
35	PETp0
37	PETn0
39	GND
41	PERp0
43	PERn0
45	GND
47	REFCLK+
49	REFCLK-
51	GND
52	PERESET#
54	W_DISABLE#2
55	PEWAKE#
56	W_DISABLE#1
57	GND
59	NC
61	NC
63	GND
64	NC
65	NC
67	NC
69	GND
71	NC
72	+3.3VSB
73	NC
74	+3.3VSB
75	GND

CN23	COM1/COM2
Part Number	1653004793
Footprint	HD_10x2P_79_23N685B-20M10
Description	BOX HEADER 10x2P 2.0mm 180D(M)SMD 23N685B-20M10B
Pin	Pin Name
1	DCD1#
2	DSR1#
3	RXD1
4	RTS1#
5	TXD1
6	CTS1#
7	DTR1#
8	RI1#
9	GND
10	GND
11	DCD2#
12	DSR2#
13	RXD2
14	RTS2#
15	TXD2
16	CTS2#
17	DTR2#
18	RI2#
19	GND
20	GND

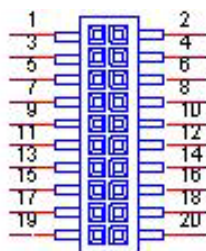

CN24	COM3/COM4/RS422/RS485
Part Number	1653004793
Footprint	HD_10x2P_79_23N685B-20M10
Description	BOX HEADER 10x2P 2.0mm 180D(M)SMD 23N685B-20M10B
Pin	Pin Name
1	422TX3-/485D3-/DCD3#
2	DSR3#
3	422TX3+/485D3+/RXD3
4	RTS3#
5	422RX3+/TXD3
6	CTS3#
7	422RX3-/DTR3#
8	RI3#
9	GND
10	GND
11	422TX4-/485D4-/DCD4#
12	DSR4#
13	422TX4+/485D4+/RXD4
14	RTS4#
15	422RX4+/TXD4
16	CTS4#
17	422RX4-/DTR4#
18	RI4#
19	GND
20	GND

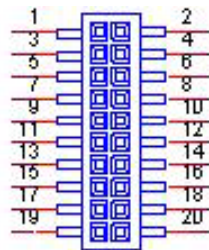

CN25	External USB3.0
Part Number	1654011725-01
Footprint	USB_9x2P_WDU3R-18F3B4PBUW3
Description	
Pin	Pin Name
1	+5V
2	D-
3	D+
4	GND
5	SSRX-
6	SSRX+
7	GND
8	SSTX-
9	SSTX+

CN26	External USB2.0
Part Number	1654009513
Footprint	USB_8P_UB1112C-8FDE-4F
Description	USB CONN. 8P 2.0mm 90D DIP UB1112C-8FDE-4F
Pin	Pin Name
1	+5V
2	D-
3	D+
4	GND

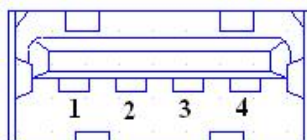

CN27	Internal USB
Part Number	1653005260
Footprint	HD_5x2P_79_N10
Description	PIN HEADER 2x5P 2.0mm 180D(M) SMD 21N22050
Pin	Pin Name
1	+5V
2	+5V
3	A_D-
4	B_D-
5	A_D+
6	B_D+
7	GND
8	GND
9	GND

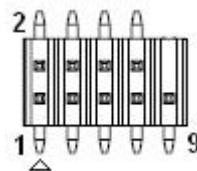

Matching Cable: 1703100260 1703100121

CN28	MIOe3.0
Part Number	00A00001150
Footprint	MIOE_CPUSIDE
Description	
Pin	Pin Name
1	GND
2	GND
3	PCIE_RX0+
4	PCIE_TX0+
5	PCIE_RX0-
6	PCIE_TX0-
7	GND
8	GND
9	PCIE_RX1+
10	PCIE_TX1+
11	PCIE_RX1-
12	PCIE_TX1-
13	GND
14	GND
15	USB1_SSRX+
16	USB1_SSTX+
17	USB1_SSRX-
18	USB1_SSTX-
19	GND

20	GND
21	SATA_RX+
22	SATA_TX+
23	SATA_RX-
24	SATA_TX-
25	GND
26	GND
27	PCIE_CLK+
28	LOUTL
29	PCIE_CLK-
30	LOUTR
31	GND
32	AGND
33	SMB_STB_CLK
34	GND
35	SMB_STB_DAT
36	USB3_D+
37	PCIE_WAKE#
38	USB3_D-
39	RESET#
40	GND
41	PowerOn
42	CLK/eSPI_CLK
43	NC
44	LPC_AD0/eSPI_IO0
45	DDP_HPD
46	LPC_AD1/eSPI_IO1
47	GND
48	LPC_AD2/eSPI_IO2
49	DDP_AUX+/DDC_CLK
50	LPC_AD3/eSPI_IO3
51	DDP_AUX-/DDC_DAT
52	LPC_DRQ#0/eSPI_CS#
53	GND
54	LPC_SERIRQ/eSPI_RESET#
55	DDP_D0+
56	LPC_FRAME#
57	DDP_D0-
58	GND
59	GND
60	USB0_D+
61	DDP_D1+
62	USB0_D-
63	DDP_D1-
64	GND
65	GND
66	USB1_D+/USB_SSTX+
67	DDP_D2+

68	USB1_D-/USB_SSTX-
69	DDP_D2-
70	GND
71	GND
72	USB2_D+/USB_SSRX+
73	DDP_D3+
74	USB2_D-/USB_SSRX-
75	DDP_D3-
76	GND
77	GND
78	USB_OC#
79	+12VSB
80	+12VSB
83	GND
84	GND
85	GND
86	GND
87	+5VSB
88	+5VSB
89	+5VSB
90	+5VSB

CN29	+12V FAN
Part Number	1655003010
Footprint	WHP3VA
Description	Wafer 2.54mm 3P 180D(M) DIP 22-27-2031
Pin	Pin Name
1	GND
2	+12V
3	SPEED

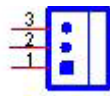

CN30	SMBus
Part Number	1655904020
Footprint	FPC4V-125M
Description	WAFER 4P 1.25mm 180D(M) SMD 85205-04001
Pin	Pin Name
1	GND
2	SMB_DAT
3	SMB_CLK
4	+5V

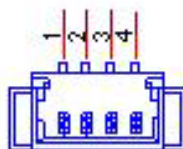

CN31	SATA
Part Number	1654011616-01
Footprint	SATA_7P_WATF-07DBN6SB1U
Description	
Pin	Pin Name
1	GND
2	TX+
3	TX-
4	GND
5	RX-
6	RX+
7	GND

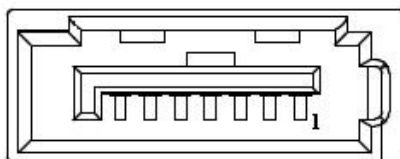

Appendix **B**

System Assignments

This appendix contains information of a detailed nature.

Sections include:

- System I/O Ports
- 1st MB Memory Map
- Interrupt Assignments

B.1 System I/O Ports

Table B.1: System I/O Ports

Addr. Range (Hex)	Device
20–2D	Interrupt Controller
2E – 2F	Motherboard resources
30 – 3D	Interrupt Controller
40 – 43	System timer
4E – 4F	Motherboard resources
50 – 53	System timer
61 – 67	Motherboard resources
70 - 7F	System CMOS/real time clock
80 - 92	Motherboard resources
A0 – B1	Interrupt Controller
B2 – B3	Motherboard resources
B4 – BD	Interrupt Controller
272 – 273	Motherboard resources
290 – 29F	Embedded Controller resources
2E8 – 2EF	COM4
2F8 – 2FF	COM2
3B0 – 3DF	Intel® HD Graphics
3E8 – 3EF	COM3
3F8 – 3FF	COM1
400 – 47F	Motherboard resources
4D0 – 4D1	Interrupt Controller
500 – 57F	Motherboard resources

B.2 1st MB Memory Map

Table B.2: 1st MB Memory Map

Addr. Range (Hex)	Device
A0000h - BFFFFh	Intel® HD Graphics
A0000h - BFFFFh	PCI Bus
C0000h - DFFFFh	PCI Bus
E0000h - FFFFFh	PCI Bus
90400000 – 905FFFFFF	Intel® Trusted Execution Engine Interface
E0000000 - FEFFFFFF	System resources

B.3 Interrupt Assignments

Table B.3: Interrupt assignments

Interrupt#	Interrupt source
NMI	Parity error detected
IRQ0	System timer
IRQ1	Using SERIRQ, Keyboard Emulation
IRQ2	Slave controller INTR output
IRQ3	Communications Port (COM2)
IRQ4	Communications Port (COM1)
IRQ5	Communications Port (COM4) / iManager WatchDog IRQ
IRQ6	Available
IRQ7	Communications Port (COM3)
IRQ8	Internal RTC or HPET
IRQ9	Microsoft ACPI-Compliant System
IRQ10	Available
IRQ11	Available
IRQ12	Available
IRQ13	Numeric data processor
IRQ14	SATA controller
IRQ15	SATA controller

Appendix **C**

EC Watchdog Timer
Sample Code

C.1 EC Watchdog Timer sample code

```
EC_Command_Port = 0x29Ah
EC_Data_Port = 0x299h
Write EC HW ram = 0x89
Watch dog event flag = 0x57
Watchdog reset delay time = 0x5E
Reset event = 0x04
Start WDT function = 0x28
=====
.model small
.486p
.stack 256
.data
.code
org 100h
.STARTup

mov dx, EC_Command_Port
mov al,89h      ; Write EC HW ram.
out dx,al

mov dx, EC_Data_Port
mov al, 5Fh    ; Watchdog reset delay time low byte (5Eh is high byte) index.
out dx,al

mov dx, EC_Data_Port
mov al, 30h    ; Set 3 seconds delay time.
out dx,al

mov dx, EC_Command_Port
mov al,89h    ; Write EC HW ram.
out dx,al

mov dx, EC_Data_Port
mov al, 57h   ; Watch dog event flag.
out dx,al

mov dx, EC_Data_Port
mov al, 04h   ; Reset event.
out dx,al

mov dx, EC_Command_Port
mov al,28h   ; start WDT function.
out dx,al

.exit
END
```

ADVANTECH

Enabling an Intelligent Planet

www.advantech.com

Please verify specifications before quoting. This guide is intended for reference purposes only.

All product specifications are subject to change without notice.

No part of this publication may be reproduced in any form or by any means, electronic, photocopying, recording or otherwise, without prior written permission of the publisher.

All brand and product names are trademarks or registered trademarks of their respective companies.

© Advantech Co., Ltd. 2017